

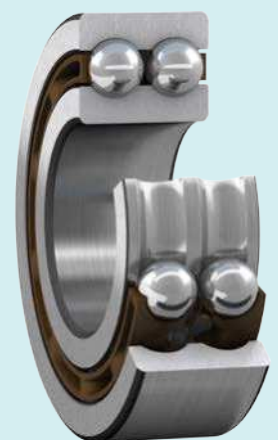

1

Deep groove ball bearings

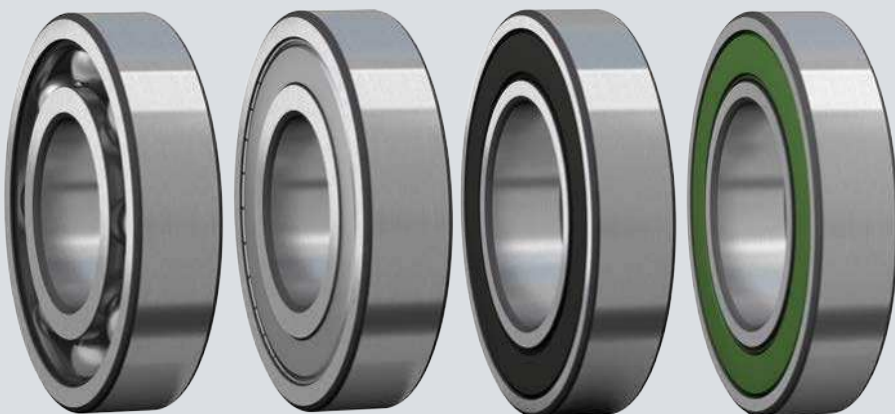

1 Deep groove ball bearings

Designs and variants	241		
Single row deep groove ball bearings	241		
Stainless steel deep groove ball bearings	241		
Single row deep groove ball bearings with filling slots	241		
Double row deep groove ball bearings	242		
Capped bearings	242		
Greases for capped bearings	244		
Bearings with a snap ring groove	247		
Bearings with a flanged outer ring	247		
SKF Explorer bearings	248		
Quiet running bearings for large electric generators	248		
Cages	249		
Matched bearings	249		
Bearing data	250		
(Dimension standards, tolerances, internal clearance, permissible misalignment)			
Loads	254		
(Minimum load, axial load carrying capacity, load carrying capacity of matched bearing pairs, equivalent dynamic bearing load, equivalent static bearing load)			
Temperature limits	256		
Permissible speed	256		
Designation system	258		
Product tables		Other deep groove ball bearings	
1.1 Single row deep groove ball bearings	260	Cam rollers	931
1.2 ICOS oil sealed bearing units	308	Sensor bearing units	987
1.3 Single row deep groove ball bearings with a snap ring groove	310	High temperature bearings	1005
1.4 Stainless steel deep groove ball bearings	316	Bearings with Solid Oil	1023
1.5 Single row deep groove ball bearings with filling slots	328	INSOCOAT bearings	1029
1.6 Double row deep groove ball bearings	334	Hybrid bearings	1043
		NoWear coated bearings	1059
		Polymer ball bearings	
			→ skf.com/bearings

1 Deep groove ball bearings

More information

General bearing knowledge	17
Bearing selection process	59
Lubrication	109
Bearing interfaces.	139
Seat tolerances for standard conditions	148
Selecting internal clearance	182
Sealing, mounting and dismounting	193

Mounting instructions for individual bearings → skf.com/mount

SKF bearing maintenance handbook ISBN 978-91-978966-4-1

Deep groove ball bearings are particularly versatile. They are suitable for high and very high speeds, accommodate radial and axial loads in both directions, and require little maintenance. Because deep groove ball bearings are the most widely used bearing type, they are available from SKF in many designs, variants and sizes.

In addition to the bearings presented in this section, deep groove ball bearings for special applications are shown under:

- *Sensor bearing units*, [page 987](#)
- *High temperature bearings and bearing units*, [page 1005](#)
- *Bearings with Solid Oil*, [page 1023](#)
- *INSOCOAT bearings*, [page 1029](#)
- *Hybrid bearings*, [page 1043](#)
- *NoWear coated bearings*, [page 1059](#)

For single row cam rollers, refer to *Cam rollers*, [page 931](#).

Designs and variants

Single row deep groove ball bearings

Single row deep groove ball bearings (fig. 1) are available capped (with seals or shields) or open. Open bearings that are also available capped may have recesses in the ring side faces (fig. 2).

SKF inch bearings in the EE(B), RLS and RMS series are intended as aftermarket items and, therefore, SKF recommends not using these bearings for new bearing arrangement designs (skf.com/go/17000-1-1).

SKF can also supply bearings with a tapered bore. For detailed information, contact SKF.

Stainless steel deep groove ball bearings

Stainless steel deep groove ball bearings (fig. 1) are available capped (with seals or shields) or open. Open bearings that are also available capped may have recesses in the ring side faces (fig. 2).

These bearings have a lower load carrying capacity than same-sized bearings made of high chromium steel.

Inch stainless steel deep groove ball bearings are not listed in this catalogue, but can be found online at skf.com/go/17000-1-4.

Single row deep groove ball bearings with filling slots

Single row deep groove ball bearings with filling slots have a filling slot in both the inner and outer rings (fig. 3) to accommodate more balls than standard deep groove ball bearings.

Filling slot bearings have a higher radial load carrying capacity than bearings without filling slots, but their axial load carrying capacity is limited. They are also unable to operate at the same high speeds as bearings without filling slots.

Deep groove ball bearings with filling slots are available open or with shields on one or both sides. They are also available with or without a snap ring groove. Open bearings that are also available with shields may have recesses in the outer ring (fig. 4).

Large size deep groove ball bearings with filling slots, without cage, are available on request.

Fig. 1

Single row bearing

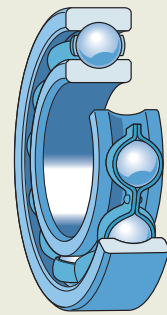

Fig. 2

Open designs

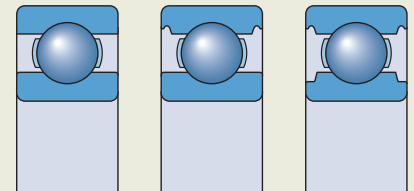

Fig. 3

Bearing with filling slots

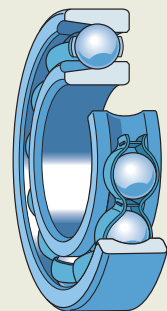
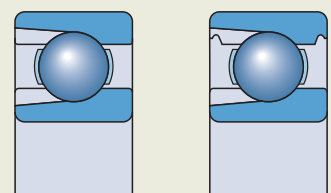

Fig. 4

Open designs of bearings with filling slots





1 Double row deep groove ball bearings

Double row deep groove ball bearings (fig. 5) are very suitable for bearing arrangements where the load carrying capacity of a single row bearing is inadequate. For the same bore and outside diameter, double row bearings are slightly wider than single row bearings in the 62 and 63 series, but have a considerably higher load carrying capacity.

Double row deep groove ball bearings are only available as open bearings (without seals or shields).

Capped bearings

Selection guidelines for different capping devices under various operating conditions are listed in table 1. However, these guidelines cannot substitute for testing a shield or seal in its application. For additional information, refer to *Integral sealing*, page 26.

The seals, which are fitted in a recess on the outer ring, make good, positive contact with the recess, without deforming the outer ring. The capping devices are available as:

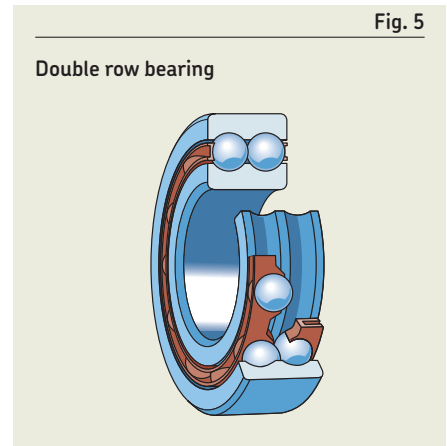

Table 1

Selection guidelines for SKF capping devices

Requirement	Shields	Non-contact seals	Low-friction seals		Contact seals	
	Z, ZS	RZ	RSL	RST	RSH	RS1
Low friction	+++	+++	++	++	o	o
High speed	+++	+++	+++	+	o	o
Grease retention	o	+	+++	+++	+++	++
Dust exclusion	o	+	++	++	+++	+++
Water exclusion						
static	-	-	o	+++	+++	++
dynamic	-	-	o	+	++	+
high pressure	-	-	o	o	+++	o
Symbols:	+++ = best	++ = very good	+ = good	o = fair	- = not recommended	

Shields (designation suffixes Z or ZS)

- are primarily intended for applications where the inner ring rotates
- are fitted in the outer ring and form a narrow gap with the inner ring
- are made of sheet steel, or stainless steel for stainless steel bearings
- protect from dirt and debris without friction losses
- are supplied in different designs (fig. 6):
 - with designation suffix Z: either with (a) or without (b) an extension in the shield bore or on some stainless steel bearings, the shield bore can extend into a recess in the inner ring (c)
 - with designation suffix ZS (stainless steel bearings only): fixed in the outer ring by a retaining ring and may extend into a recess (d)
 - available on request for stainless steel bearings only: shields made of PTFE

Non-contact seals (designation suffix RZ)

- provide better sealing effectiveness than shields
- can be operated at the same speeds as shields
- form an extremely narrow gap with the inner ring shoulder (fig. 7)
- are made of sheet steel reinforced NBR (oil- and wear-resistant)

Low-friction seals (designation suffixes RSL or RST)

- provide better sealing effectiveness than non-contact seals
- are made of sheet steel reinforced NBR (oil- and wear-resistant)

RSL design (fig. 8):

- can be operated at the same speeds as shields
- make virtually no contact with a recess in the inner ring shoulder
- are available for 60, 62, 63 series bearings in two designs, depending on the size

RST design (fig. 9):

- make positive contact with a recess in the inner ring shoulder for good sealing effectiveness
- are available on request for 60, 62 and 63 series bearings in three designs, depending on the size

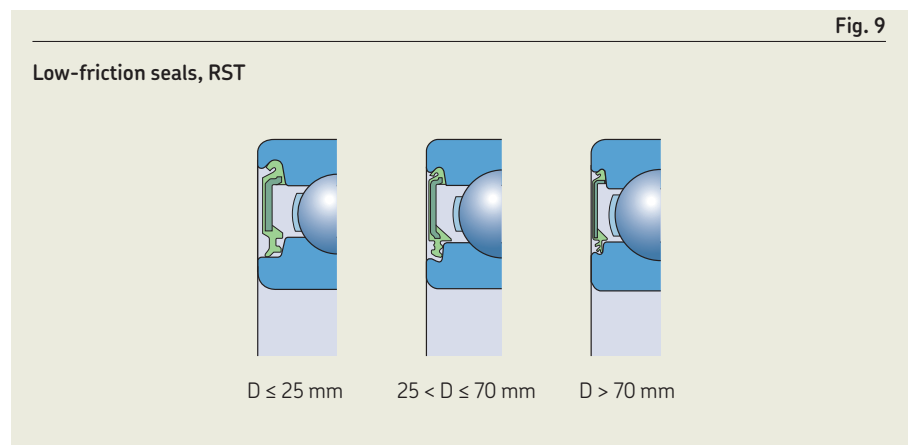
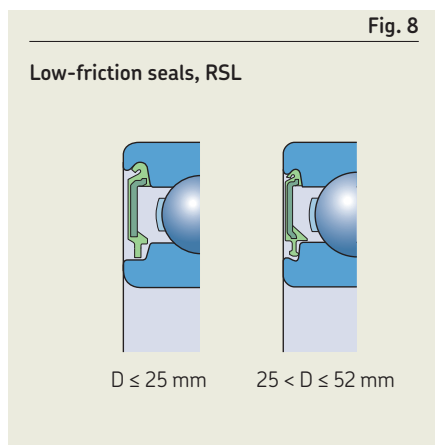
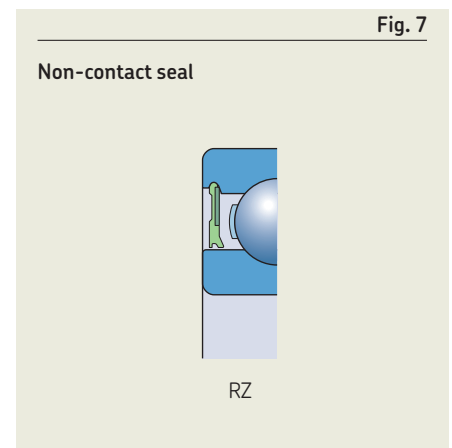
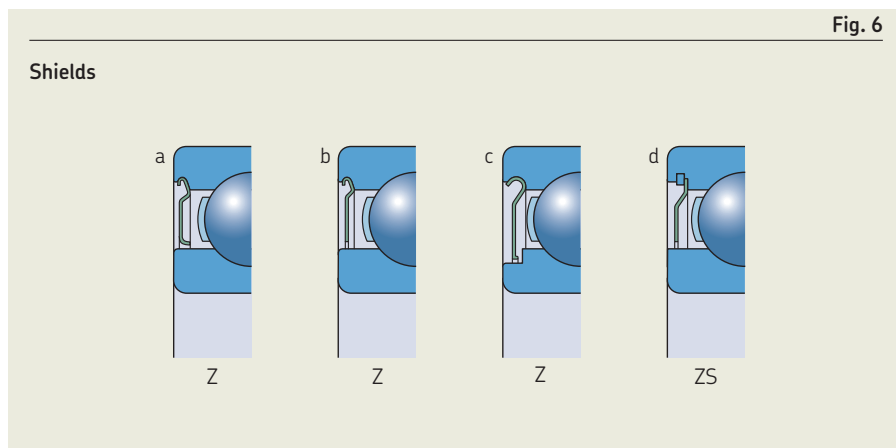

1 Deep groove ball bearings

Contact seals (designation suffixes RSH, RSH2, RS1, RS1/VP311 or RS2)

- are made of sheet steel reinforced
 - NBR
 - FKM (designation suffix RS2 or RSH2, available on request)
 - food compatible, blue-coloured NBR* (designation suffix VP311 and for stainless steel bearings only)
- are available in different designs depending on the bearing they are used with (fig. 10):
 - for 60, 62 and 63 series bearings in two RSH designs (a, b), depending on the size
 - for RS1 designs, with sealing either against the inner ring shoulder (c) or against a recess in the inner ring side face for chromium steel bearings (d) or for stainless steel bearings (e), the relevant design is determined by dimension d_1 or d_2 in the product table.

ICOS oil sealed bearing units

- are typically used for applications with sealing requirements exceeding the capabilities of standard sealing solutions, i.e. oil retention
- have the following features compared to bearings with external sealing solutions:
 - need less axial space
 - simplify mounting
 - avoid expensive machining of the shaft because the inner ring shoulder is the seal counterface

* The material is FDA and EC approved. FDA approval is based on compliance with CFR 21 section 177.2600 "Rubber articles intended for repeated use" for use in contact with aqueous and fatty foods. EC approval is based on compliance with the overall migration requirements of the German BfR recommendation XXI for category 3 materials.

- consist of a 62 series deep groove ball bearing and an SKF WAVE seal (fig. 11):
 - single lip, spring loaded radial shaft seal
 - made of NBR
- have limiting speeds quoted in the product table that are based on the permissible circumferential speed for the seal (14 m/s)

Greases for capped bearings

Bearings capped on both sides are lubricated for the life of the bearing and are virtually maintenance-free.

They are filled with one of the following greases:

Single row bearings

- standard bearings (table 2)

On request, bearings can be supplied with the following special greases:

- high temperature grease GJN
- wide temperature range grease HT or WT
- wide temperature range and low-noise grease LHT23
- low temperature grease LT

Stainless steel bearings

- wide temperature range and low-noise grease LHT23 as standard
- GFJ food-grade grease, registered by NSF as category H1 (designation suffix VP311)

The NSF registration confirms the grease fulfils the requirements listed in the US Food and Drug Administration's guidelines under 21 CFR section 178.3570 (lubricant acceptable with incidental food contact for use in and around food processing areas).
- available on request: special non-toxic grease, registered by NSF as category H1 (designation suffix VT378)

Bearings with filling slots

- high temperature grease GJN

On request, bearings can be supplied with the following special greases:

- wide temperature range grease HT or WT
- wide temperature range and low-noise grease LHT23
- low temperature grease LT

The technical specifications of the various greases are listed in table 3.

The standard grease is not identified in the bearing designation (no designation suffix). Special greases are indicated by the corresponding grease suffix. Check availability of bearings with special grease prior to ordering.

⚠ WARNING

Seals made of FKM (fluoro rubber) exposed to an open flame or temperatures above 300 °C (570 °F) are a health and environmental hazard! They remain dangerous even after they have cooled.

Read and follow the safety precautions on page 197.

Fig. 10

Contact seals

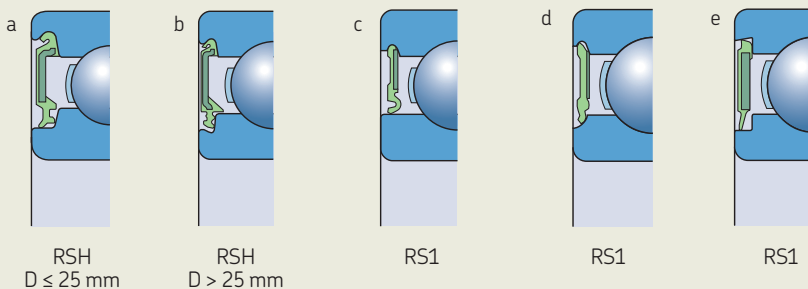

Fig. 11

ICOS oil sealed bearing unit

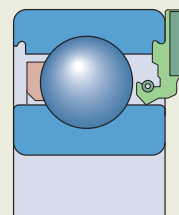

Table 2



SKF standard greases for capped single row deep groove ball bearings made of carbon chromium steel

Bearings in diameter series	SKF standard greases in bearings with outside diameter			
	D ≤ 30 mm d < 10 mm	d ≥ 10 mm	30 < D ≤ 62 mm	D > 62 mm
8, 9	LHT23	LT10	MT47	MT33
0, 1, 2, 3	MT47	MT47	MT47	MT33

Table 3

Technical specifications of SKF standard and special greases for capped deep groove ball bearings

Grease	Temperature range ¹⁾							Thickener	Base oil type	NLGI grade	Base oil viscosity [mm ² /s]		Grease performance factor (GPF)
	-50	0	50	100	150	200	250				at 40 °C (105 °F)	at 100 °C (210 °F)	
MT33								Lithium soap	Mineral	3	100	10	1
MT47								Lithium soap	Mineral	2	70	7,3	1
LT10								Lithium soap	Diester	2	12	3,3	2
LHT23								Lithium soap	Ester	2-3	27	5,1	2
LT								Lithium soap	Diester	2	15	3,7	1
WT								Polyurea	Ester	2-3	70	9,4	4
GJN								Polyurea	Mineral	2	115	12,2	2
HT								Polyurea	Mineral	2-3	96	10,5	2
VT378								Aluminium complex soap	PAO	2	150	15,5	- ²⁾
GFJ								Aluminium complex soap	Synthetic hydro-carbon	2	100	14	1
GE2								Lithium soap	Synthetic	2	25	4,9	2

¹⁾ Refer to the SKF traffic light concept (page 117).

²⁾ For bearings filled with VT378 grease, use the scale corresponding to GPF = 1 and multiply the value obtained from diagram 1, page 246, by 0,2.

1 Deep groove ball bearings

Grease life for capped bearings

- is presented as L_{10} , i.e. the time period at the end of which 90% of the bearings are still reliably lubricated (**diagram 1**)
- depends on:
 - the operating temperature
 - the speed factor, nd_m
 - grease performance factor (GPF) (**table 3, page 245**)

The indicated grease life is valid under this combination of operating conditions:

- horizontal shaft
- inner ring rotation
- light load ($P \leq 0,05 C$)
- operating temperature within the green temperature zone of the grease (**table 3**)
- stationary machine
- low vibration levels

Where the operating conditions differ as described below, the grease life obtained from the diagram should be adjusted:

- for vertical shafts, use 50% of the obtained value
- for heavier loads ($P > 0,05 C$), apply a reduction factor (**table 4**)

When capped bearings must operate under certain extreme conditions, such as very high speeds or high temperatures, grease may appear on the capping diameter. For bearing arrangements where this would be detrimental, appropriate actions could be taken. For additional information, contact the SKF application engineering service.

Table 4

Reduction factor for the grease life, depending on the load

Load P	Reduction factor
$\leq 0,05 C$	1
0,1 C	0,7
0,125 C	0,5
0,25 C	0,2

Diagram 1

Grease life for capped deep groove ball bearings where $P = 0,05 C$

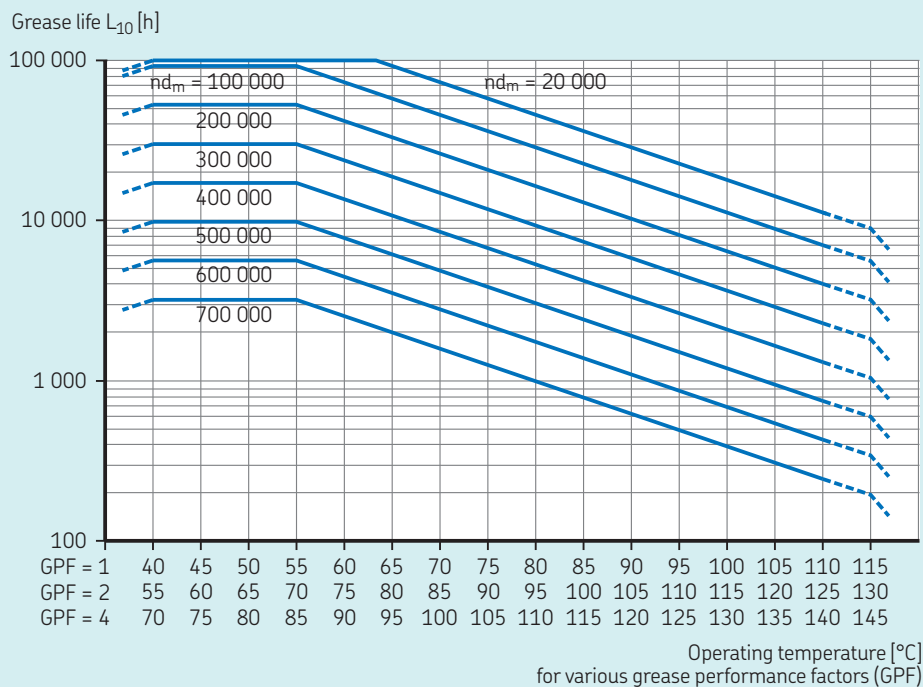

n = rotational speed [r/min]
 d_m = bearing mean diameter [mm]
 $= 0,5(d + D)$

Bearings with a snap ring groove

- can simplify the design of an arrangement
 - by locating the bearing axially in the housing by a snap ring (fig. 12)
 - by saving space
 - by significantly reducing mounting time.

Appropriate snap rings are shown in the product table along with their designation and dimensions.

The following variants are available (fig. 13):

- open bearings with a snap ring groove only (designation suffix N)
- open bearings with a snap ring (designation suffix NR)
- bearings with a snap ring and a shield on the opposite side (designation suffix ZNR)
- bearings with a snap ring and a shield on the same side (designation suffix ZNBR)
- bearings with a snap ring and a shield on both sides (designation suffix 2ZNR)

Bearings with a flanged outer ring

Certain sizes of SKF stainless steel deep groove ball bearings are also available with a flange on the outer ring (designation suffix R, fig. 14). They:

- can be supplied open or capped
- are relatively easy to locate axially in the housing
- enable easier and more cost-effective housing bore manufacture, no shoulders required

These bearings with a flanged outer ring are not listed in this catalogue, but can be found online at skf.com/go/17000-1-4.

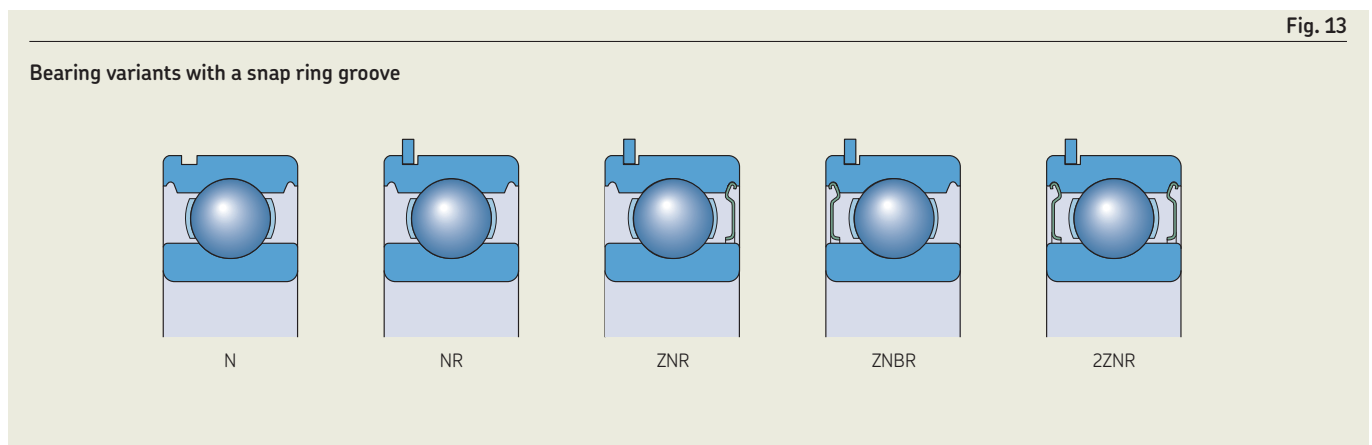
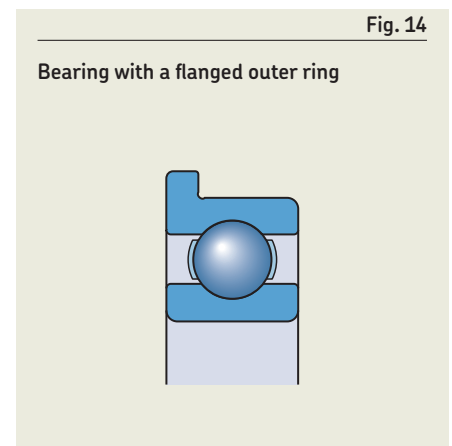
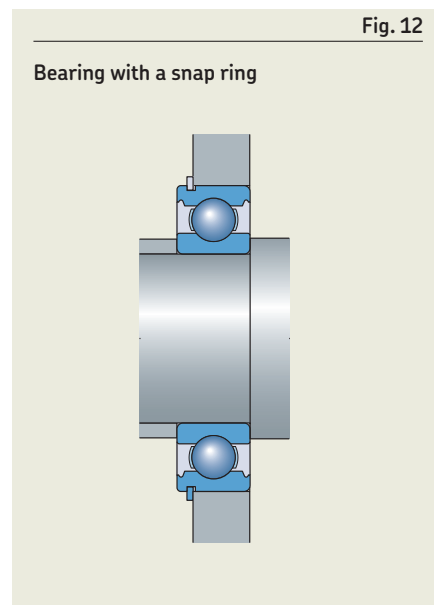



SKF Explorer bearings

Single row deep groove ball bearings are also available as SKF Explorer bearings (page 7).

Quiet running bearings for large electric generators

- are designed to comply with stringent noise requirements
- are typically used in wind turbine generators
- provide consistent performance over a variety of operating conditions
- are identified by the designation suffix VQ658

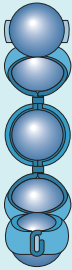
Table 5

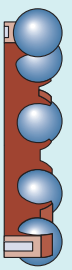
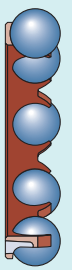
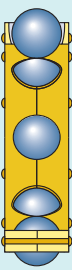
Cages	Steel cages			Polymer cages			Brass cages
							
Cage type	Ribbon-type, ball centred	Riveted, ball centred	Snap-type, ball centred	Snap-type, ball centred			Riveted, ball, outer ring or inner ring centred
Material	Stamped steel / stainless steel			PA66, glass fibre reinforced	PA46, glass fibre reinforced	PEEK, glass fibre reinforced	Machined brass
Suffix	–	–	–	TN9	TN9/VG1561	TNH	M, MA or MB
Single row bearings	Standard (metric only)	Standard (a)	–	Standard for inch bearings and ICOS oil sealed bearing units, check availability for other bearings	Check availability (not available for inch bearings)	Check availability (not available for inch bearings)	Standard (metric only)
Stainless steel bearings	Standard	Standard (a)	Standard	Check availability	–	–	–
Bearings with filling slots	–	Standard (b)	–	–	–	–	–
Double row bearings	–	–	–	Standard	–	–	–

Cages

Depending on their design, series and size, SKF deep groove ball bearings are fitted with one of the cages shown in [table 5](#). Double row bearings are equipped with two cages. The standard stamped steel cage is not identified in the bearing designation. If non-standard cages are required, check availability prior to ordering.

When used at high temperatures, some lubricants can have a detrimental effect on polyamide cages. For additional information about the suitability of cages, refer to *Cages*, [page 187](#).

Matched bearings

- are used where the load carrying capacity of a single bearing is inadequate
- are used where the shaft has to be located axially in both directions with a specific axial clearance
- where mounted immediately adjacent to each other, distribute the load between the bearings without having to use shims or similar devices

A 'V-shaped' marking on the outside surface of the outer rings of matched bearings ([fig. 15](#)) indicates how the pair should be mounted. The bearing pairs are supplied as a packaged unit.

Matched pairs can be supplied in three different arrangements ([fig. 16](#)):

Tandem arrangement (designation suffix DT)

- is used where the load carrying capacity of a single bearing is inadequate
- has parallel load lines and therefore shares the radial and axial loads equally
- can accommodate axial loads in both directions

Back-to-back arrangement (designation suffix DB)

- has load lines that diverge towards the bearing axis
- provides a relatively stiff bearing arrangement
- can accommodate tilting moments
- can accommodate axial loads in both directions, but only by one bearing in each direction

Face-to-face arrangement (designation suffix DF)

- has load lines that converge towards the bearing axis
- is less sensitive to misalignment but not as stiff as a back-to-back arrangement
- can accommodate axial loads in both directions, but only by one bearing in each direction

Fig. 15

'V-shaped' marking on matched bearings

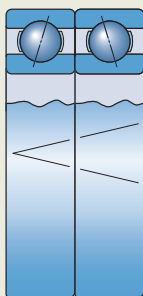
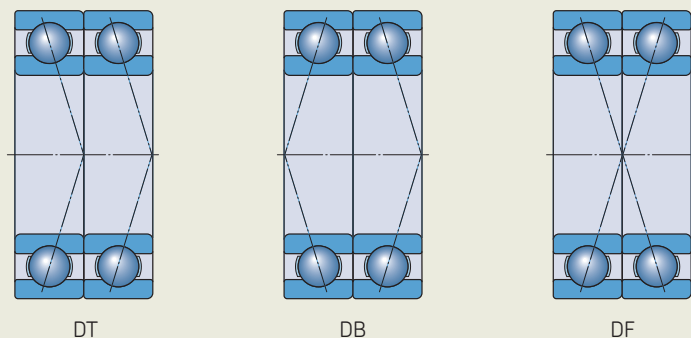

Fig. 16

Matched bearings in different arrangements





Bearing data

Single row deep groove ball bearings

Dimension standards

Boundary dimensions: ISO 15
Snap rings and grooves: ISO 464

Tolerances

Normal
P6 or P5 on request

Except for:

SKF Explorer bearings

Dimensional tolerances to P6 and tighter width tolerance:

$D \leq 110 \text{ mm} \rightarrow 0 / -60 \mu\text{m}$

$D > 110 \text{ mm} \rightarrow 0 / -100 \mu\text{m}$

Geometrical tolerances:

$D \leq 52 \text{ mm} \rightarrow \text{P5}$

$52 \text{ mm} < D \leq 110 \text{ mm} \rightarrow \text{P6}$

$D > 110 \text{ mm} \rightarrow \text{Normal}$

For additional information

→ [page 35](#)

Values: ISO 492 ([table 2, page 38](#), to [table 4, page 40](#))

Internal clearance

Single bearings

Normal

Check availability of C2, C3, C4, C5, reduced ranges of standard clearance classes or partitions of adjacent classes.

Matched bearing pairs

Supplied either with clearance or preload:

- CA – small axial internal clearance
- GA – light preload

For additional information

→ [page 182](#)

Values: ISO 5753-1 ([table 6, page 252](#)), except for stainless steel bearings with $d < 10 \text{ mm}$ ([table 7, page 253](#)) ...

Permissible misalignment

≈ 2 to 10 minutes of arc (single bearings)

Misalignment increases bearing noise and reduces bearing service life, and when it exceeds the guideline values these effects become particularly noticeable. For matched bearing pairs, any misalignment increases bearing ...

Stainless steel deep groove ball bearings	Single row deep groove ball bearings with filling slots	Double row deep groove ball bearings
Boundary dimensions: ISO 15 Except for: <ul style="list-style-type: none"> • bearings with suffix X • bearings with prefix WBB1 • outer ring flange of flanged bearings: ISO 8443 	Boundary dimensions: ISO 15 Snap rings and grooves: ISO 464	Boundary dimensions: ISO 15
Normal P6 or P5 on request	Normal	Normal
Normal Check availability of other clearance classes	Normal	Normal Check availability of C3 clearance class
... and for matched bearing pairs (table 8, page 253). Values are valid for unmounted bearings under zero measuring load.		
≈ 2 to 10 minutes of arc	≈ 2 to 5 minutes of arc	≤ 2 minutes of arc
... noise and reduces bearing service life. For additional information, contact the SKF application engineering service.		

Radial internal clearance of deep groove ball bearings

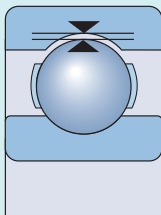

Bore diameter		Radial internal clearance									
d		C2		Normal		C3		C4		C5	
>	≤	min.	max.	min.	max.	min.	max.	min.	max.	min.	max.
mm		μm									
2,5	6	0	7	2	13	8	23	–	–	–	–
6	10	0	7	2	13	8	23	14	29	20	37
10	18	0	9	3	18	11	25	18	33	25	45
18	24	0	10	5	20	13	28	20	36	28	48
24	30	1	11	5	20	13	28	23	41	30	53
30	40	1	11	6	20	15	33	28	46	40	64
40	50	1	11	6	23	18	36	30	51	45	73
50	65	1	15	8	28	23	43	38	61	55	90
65	80	1	15	10	30	25	51	46	71	65	105
80	100	1	18	12	36	30	58	53	84	75	120
100	120	2	20	15	41	36	66	61	97	90	140
120	140	2	23	18	48	41	81	71	114	105	160
140	160	2	23	18	53	46	91	81	130	120	180
160	180	2	25	20	61	53	102	91	147	135	200
180	200	2	30	25	71	63	117	107	163	150	230
200	225	2	35	25	85	75	140	125	195	175	265
225	250	2	40	30	95	85	160	145	225	205	300
250	280	2	45	35	105	90	170	155	245	225	340
280	315	2	55	40	115	100	190	175	270	245	370
315	355	3	60	45	125	110	210	195	300	275	410
355	400	3	70	55	145	130	240	225	340	315	460
400	450	3	80	60	170	150	270	250	380	350	520
450	500	3	90	70	190	170	300	280	420	390	570
500	560	10	100	80	210	190	330	310	470	440	630
560	630	10	110	90	230	210	360	340	520	490	700
630	710	20	130	110	260	240	400	380	570	540	780
710	800	20	140	120	290	270	450	430	630	600	860
800	900	20	160	140	320	300	500	480	700	670	960
900	1 000	20	170	150	350	330	550	530	770	740	1 040
1 000	1 120	20	180	160	380	360	600	580	850	820	1 150
1 120	1 250	20	190	170	410	390	650	630	920	890	1 260
1 250	1 400	30	200	190	440	420	700	680	1 000	–	–
1 400	1 600	30	210	210	470	450	750	730	1 060	–	–

Table 7

Radial internal clearance of stainless steel deep groove ball bearings with a bore diameter < 10 mm

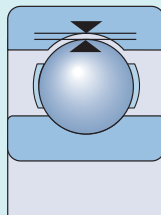

Bore diameter		Radial internal clearance											
d	≤	C1		C2		Normal		C3		C4		C5	
>		min.	max.	min.	max.	min.	max.	min.	max.	min.	max.	min.	max.
mm		μm											
–	9,525	0	5	3	8	5	10	8	13	13	20	20	28

Table 8

Axial internal clearance and preload of matched bearings in the 60, 62 and 63 series

Bore diameter		Axial internal clearance		Preload		
d	≤	CA		GA		
>		min.	max.	Bearings of series		
mm		μm		60	62	63
				N		
–	10	15	35	30	30	–
10	18	20	40	50	50	100
18	30	25	45	100	100	100
30	50	35	55	100	100	200
50	80	40	70	200	200	350
80	120	50	80	300	400	600
120	180	60	100	500	700	900
180	250	70	110	800	1 000	1 200
250	315	80	120	–	–	–
315	400	90	130	–	–	–
400	500	100	140	–	–	–

Loads

	Single row deep groove ball bearings	Stainless steel deep groove ball bearings
Minimum load For additional information → page 106	$F_{rm} = k_r \left(\frac{v n}{1\,000} \right)^{2/3} \left(\frac{d_m}{100} \right)^2$ <p>If minimum load cannot be reached, consider preloading.</p>	
Axial load carrying capacity	Pure axial load → $F_a \leq 0,5 C_0$ Small bearings ¹⁾ and light series bearings ²⁾ → $F_a \leq 0,25 C_0$ Excessive axial load can lead to a considerable reduction in bearing service life.	Pure axial load → $F_a \leq 0,25 C_0$
Load carrying capacity of matched bearing pairs	The values for basic load ratings and fatigue load limits listed in the product table apply to single bearings. For matched bearing pairs mounted immediately adjacent to each other the following values apply: <ul style="list-style-type: none"> • basic dynamic load rating $C = 1,62 C_{\text{single bearing}}$ • basic static load rating $C_0 = 2 C_{0 \text{ single bearing}}$ • fatigue load limit $P_u = 2 P_{u \text{ single bearing}}$ 	
Equivalent dynamic bearing load For additional information → page 91	Single bearings and bearing pairs arranged in tandem: $F_a/F_r \leq e \rightarrow P = F_r$ $F_a/F_r > e \rightarrow P = X F_r + Y F_a$ Bearing pairs arranged back-to-back or face-to-face: $F_a/F_r \leq e \rightarrow P = F_r + Y_1 F_a$ $F_a/F_r > e \rightarrow P = 0,75 F_r + Y_2 F_a$	$F_a/F_r \leq e \rightarrow P = F_r$ $F_a/F_r > e \rightarrow P = X F_r + Y F_a$
Equivalent static bearing load For additional information → page 105	Single bearings and bearing pairs arranged in tandem: $P_0 = 0,6 F_r + 0,5 F_a$ $P_0 < F_r \rightarrow P_0 = F_r$ Bearing pairs arranged back-to-back or face-to-face: $P_0 = F_r + 1,7 F_a$	$P_0 = 0,6 F_r + 0,5 F_a$ $P_0 < F_r \rightarrow P_0 = F_r$

1) $d \leq 12$ mm

2) Diameter series 8, 9, 0, and 1

Single row deep groove ball bearings with filling slots	Double row deep groove ball bearings	Symbols
$F_a \leq 0,6 F_r$	Pure axial load $\rightarrow F_a \leq 0,5 C_0$	<p>Symbols</p> <p>C_0 basic static load rating [kN] <ul style="list-style-type: none"> • single bearings (product tables, page 260) • matched bearing pairs (<i>Load carrying capacity of matched bearing pairs</i>) </p> <p>d_m bearing mean diameter [mm] $= 0,5 (d + D)$</p> <p>e limit for the load ratio depending on the relationship $f_0 F_a / C_0$ (table 9, page 257, and table 10, page 257)</p> <p>f_0 calculation factor (product tables)</p> <p>F_a axial load [kN]</p> <p>F_r radial load [kN]</p> <p>F_{rm} minimum radial load [kN]</p> <p>k_r minimum load factor (product tables)</p> <p>n rotational speed [r/min]</p> <p>P equivalent dynamic bearing load [kN]</p> <p>P_0 equivalent static bearing load [kN]</p> <p>X calculation factor for the radial load (table 9)</p> <p>Y, Y_1, Y_2 calculation factors for the axial load depending on the relationship $f_0 F_a / C_0$ (table 9 and table 10)</p> <p>ν actual operating viscosity of the lubricant [mm²/s]</p>
$F_a / F_r \leq 0,6$ and $P \leq 0,5 C_0$ $\rightarrow P = F_r + F_a$	$F_a / F_r \leq e \rightarrow P = F_r$ $F_a / F_r > e \rightarrow P = X F_r + Y F_a$	
$F_a / F_r \leq 0,6 \rightarrow P_0 = F_r + 0,5 F_a$	$P_0 = 0,6 F_r + 0,5 F_a$ $P_0 < F_r \rightarrow P_0 = F_r$	



1 Temperature limits

The permissible operating temperature for deep groove ball bearings can be limited by:

- the dimensional stability of the bearing rings and balls
- the cage
- the seals
- the lubricant

Where temperatures outside the permissible range are expected, contact SKF.

Bearing rings and balls

SKF deep groove ball bearings are heat stabilized up to at least 120 °C (250 °F).

Cages

Steel, stainless steel, brass or PEEK cages can be used at the same operating temperatures as the bearing rings and balls. For temperature limits of cages made of other polymer materials, refer to *Polymer cages*, page 188.

Seals

The permissible operating temperature for seals depends on the seal material:

- NBR: -40 to +100 °C (-40 to +210 °F)
Temperatures up to 120 °C (250 °F) can be tolerated for brief periods.
- FKM: -30 to +200 °C (-20 to +390 °F)
Temperatures up to 230 °C (445 °F) can be tolerated for brief periods.

Typically, temperature peaks are at the seal lip.

Lubricants

Temperature limits for greases used in SKF deep groove ball bearings capped on both sides are provided in [table 3, page 245](#). For temperature limits of other SKF greases, refer to *Selecting a suitable SKF grease*, page 116.

When using lubricants not supplied by SKF, temperature limits should be evaluated according to the SKF traffic light concept ([page 117](#)).

Permissible speed

The speed ratings in the product table indicate:

- the **reference speed**, which enables a quick assessment of the speed capabilities from a thermal frame of reference
- the **limiting speed**, which is a mechanical limit that should not be exceeded unless the bearing design and the application are adapted for higher speeds

For additional information, refer to *Operating temperature and speed*, page 130.

SKF recommends oil lubrication for bearings with a ring centred cage (designation suffix MA or MB). When these bearings are grease lubricated, the nd_m value is limited to 250 000 mm/min.

where

$$d_m = \text{bearing mean diameter [mm]} \\ = 0,5 (d + D) \\ n = \text{rotational speed [r/min]}$$

Table 9

Calculation factors for deep groove ball bearings

$f_0 F_a / C_0$	Single row and double row bearings Normal clearance			Single row bearings C3 clearance			C4 clearance		
	e	X	Y	e	X	Y	e	X	Y
0,172	0,19	0,56	2,3	0,29	0,46	1,88	0,38	0,44	1,47
0,345	0,22	0,56	1,99	0,32	0,46	1,71	0,4	0,44	1,4
0,689	0,26	0,56	1,71	0,36	0,46	1,52	0,43	0,44	1,3
1,03	0,28	0,56	1,55	0,38	0,46	1,41	0,46	0,44	1,23
1,38	0,3	0,56	1,45	0,4	0,46	1,34	0,47	0,44	1,19
2,07	0,34	0,56	1,31	0,44	0,46	1,23	0,5	0,44	1,12
3,45	0,38	0,56	1,15	0,49	0,46	1,1	0,55	0,44	1,02
5,17	0,42	0,56	1,04	0,54	0,46	1,01	0,56	0,44	1
6,89	0,44	0,56	1	0,54	0,46	1	0,56	0,44	1

Calculation factors must be selected according to the operating clearance in the bearing, which may differ from the internal clearance before mounting. For additional information or for calculation factors for other clearance classes, contact the SKF application engineering service. Intermediate values can be obtained by linear interpolation.

Table 10

Calculation factors for paired single row deep groove ball bearings
arranged back-to-back and face-to-face

$f_0 F_a / C_0$	e	Y_1	Y_2
0,17	0,23	2,8	3,7
0,69	0,30	2,1	2,8
2,08	0,40	1,6	2,15
3,46	0,45	1,4	1,85
5,19	0,50	1,26	1,7

Designation system

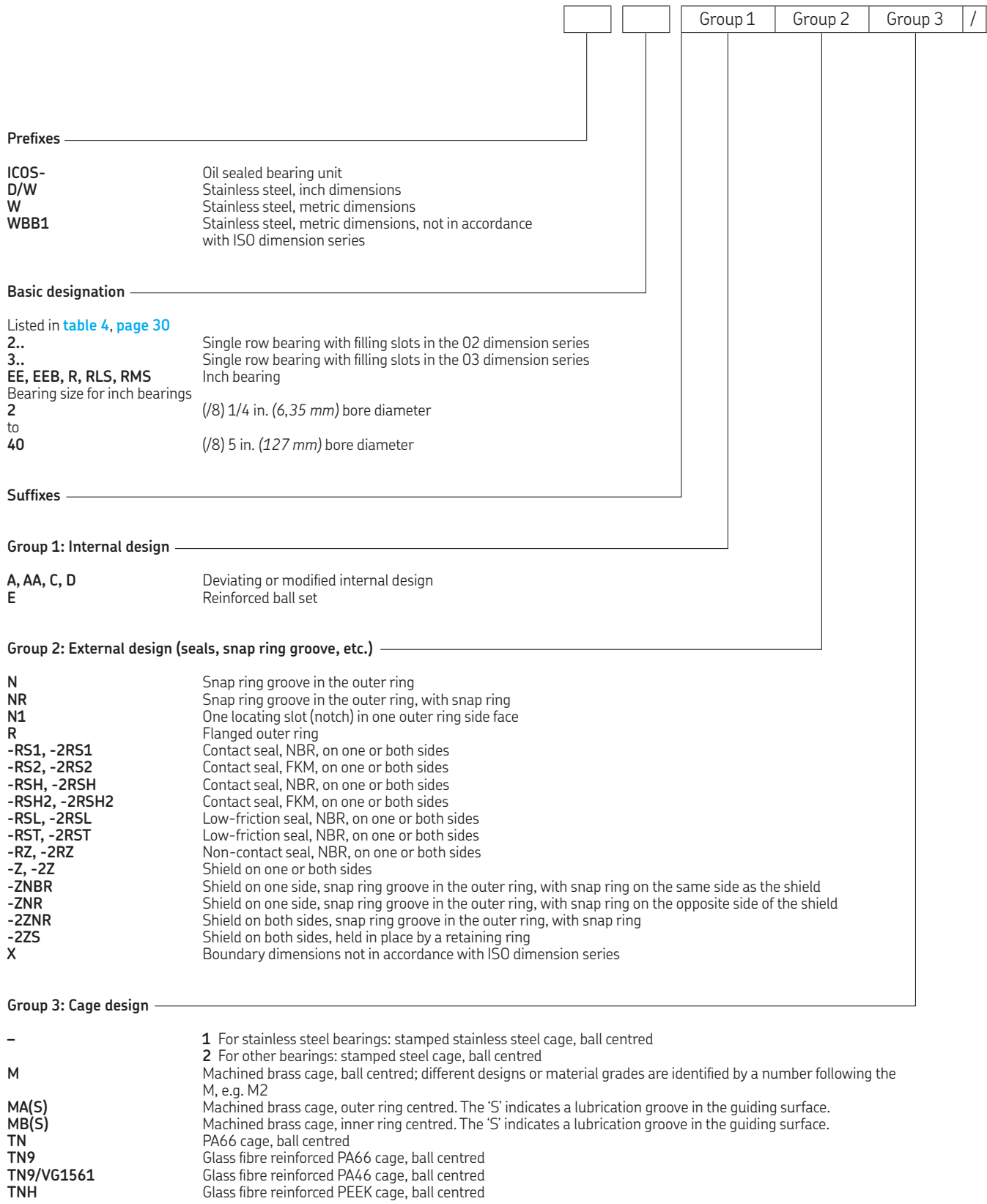

Group 4					
4.1	4.2	4.3	4.4	4.5	4.6

Group 4.6: Other variants

- VP311** SKF Food Line bearing: Blue-coloured contact seal made of FDA and EC approved NBR and lubricant (GFJ) registered by NSF as category H1
- VQ658** Quiet running properties

Group 4.5: Lubrication

- GE2
 - GFJ
 - GJN
 - HT
 - LHT23
 - LT
 - LT10
 - MT33
 - MT47
 - VT378
 - WT
- } Grease suffixes ([table 3, page 245](#))

Group 4.4: Stabilization

- S0** Bearing rings heat stabilized for operating temperatures ≤ 150 °C (300 °F)
- S1** Bearing rings heat stabilized for operating temperatures ≤ 200 °C (390 °F)

Group 4.3: Bearing sets, matched bearings

- DB** Two bearings matched for mounting back-to-back
- DF** Two bearings matched for mounting face-to-face
- DT** Two bearings matched for mounting in tandem

Group 4.2: Accuracy, clearance, preload, quiet running

- P5** Dimensional and running tolerances to class P5
- P6** Dimensional and running tolerances to class P6
- P52** P5 + C2
- P62** P6 + C2
- P63** P6 + C3
- CN** Normal radial internal clearance; only used together with an additional letter that identifies a reduced or displaced clearance range
 H = Reduced clearance range corresponding to the upper half of the actual clearance range
 L = Reduced clearance range corresponding to the lower half of the actual clearance range
 P = Displaced clearance range comprising the upper half of the actual clearance range plus the lower half of the next larger clearance range
 The above letters are also used together with the clearance classes C2, C3, C4 and C5, e.g. C2H.
- C1** Radial internal clearance smaller than C2
- C2** Radial internal clearance smaller than Normal
- C3** Radial internal clearance greater than Normal
- C4** Radial internal clearance greater than C3
- C5** Radial internal clearance greater than C4
- CA** Matched bearing set with small axial internal clearance
- GA** Matched bearing set with light preload

Group 4.1: Materials, heat treatment

- HA1** Case-hardened inner and outer rings

1.1 Single row deep groove ball bearings

d 3 – 6 mm

1.1

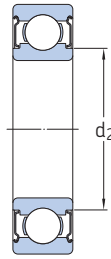
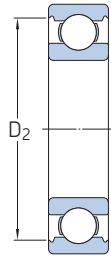
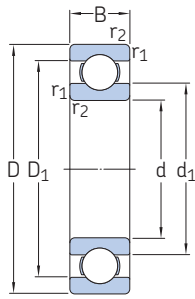

ZZ

2RSL

2RZ



2RS1

2RSH

ZZ

Principal dimensions			Basic load ratings		Fatigue load limit	Speed ratings		Mass	Designations	
d	D	B	C	C ₀	P _u	Reference speed	Limiting speed ¹⁾		Bearing open or capped on both sides	capped on one side ¹⁾
mm			kN		kN	r/min		kg	–	
3	10	4	0,54	0,18	0,007	130 000	80 000	0,0015	▶ 623	–
	10	4	0,54	0,18	0,007	–	40 000	0,0015	▶ 623-2RS1	623-RS1
	10	4	0,54	0,18	0,007	130 000	60 000	0,0015	▶ 623-ZZ	623-Z
4	9	2,5	0,423	0,116	0,005	140 000	85 000	0,0007	618/4	–
	9	3,5	0,54	0,18	0,07	140 000	70 000	0,001	628/4-2Z	–
	9	4	0,54	0,18	0,07	140 000	70 000	0,0013	638/4-2Z	–
	11	4	0,624	0,18	0,008	130 000	63 000	0,0017	619/4-2Z	–
	11	4	0,624	0,18	0,008	130 000	80 000	0,0017	619/4	–
	12	4	0,806	0,28	0,012	120 000	75 000	0,0021	604	–
	12	4	0,806	0,28	0,012	120 000	60 000	0,0021	▶ 604-2Z	604-Z
	13	5	0,936	0,29	0,012	110 000	67 000	0,0031	▶ 624	–
	13	5	0,936	0,29	0,012	110 000	53 000	0,0031	▶ 624-2Z	624-Z
	16	5	1,11	0,38	0,016	95 000	60 000	0,0054	634	–
	16	5	1,11	0,38	0,016	–	28 000	0,0054	634-2RS1	634-RS1
	16	5	1,11	0,38	0,016	95 000	48 000	0,0054	634-2RZ	634-RZ
5	16	5	1,11	0,38	0,016	95 000	48 000	0,0054	▶ 634-2Z	634-Z
	11	3	0,468	0,143	0,006	120 000	75 000	0,0012	618/5	–
	11	4	0,64	0,26	0,011	120 000	60 000	0,0014	628/5-2Z	–
	11	5	0,64	0,26	0,011	120 000	60 000	0,0016	638/5-2Z	–
	13	4	0,884	0,335	0,014	110 000	50 000	0,0025	619/5-2Z	–
	13	4	0,884	0,335	0,014	110 000	70 000	0,0025	619/5	–
	16	5	1,14	0,38	0,016	95 000	60 000	0,005	▶ 625	–
	16	5	1,14	0,38	0,016	95 000	48 000	0,005	▶ 625-2Z	625-Z
	19	6	2,34	0,95	0,04	80 000	50 000	0,0085	635	–
	19	6	2,34	0,95	0,04	–	24 000	0,009	635-2RS1	635-RS1
	19	6	2,34	0,95	0,04	80 000	40 000	0,009	635-2RZ	635-RZ
	19	6	2,34	0,95	0,04	80 000	40 000	0,0093	▶ 635-2Z	635-Z
6	13	3,5	0,715	0,224	0,01	110 000	67 000	0,002	618/6	–
	13	5	0,88	0,35	0,015	110 000	53 000	0,0026	628/6-2Z	–
	15	5	0,884	0,27	0,011	100 000	50 000	0,0039	619/6-2Z	–
	15	5	0,884	0,27	0,011	100 000	63 000	0,0039	619/6	–
	19	6	2,34	0,95	0,04	80 000	50 000	0,0081	▶ 626	–
	19	6	2,34	0,95	0,04	–	24 000	0,0083	▶ 626-2RSH	626-RSH
	19	6	2,34	0,95	0,04	80 000	40 000	0,0083	▶ 626-2RSL	626-RSL
	19	6	2,34	0,95	0,04	80 000	40 000	0,0088	▶ 626-2Z	626-Z

SKF Explorer bearing

▶ Popular item

¹⁾ For bearings with only one shield or one non-contact seal (Z, RZ) the limiting speeds of the open bearings are valid.

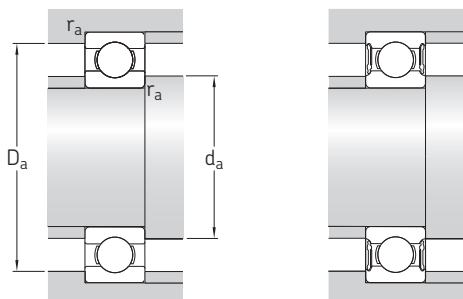

Dimensions						Abutment and fillet dimensions				Calculation factors		
d	d ₁ ≈	d ₂ ≈	D ₁ ≈	D ₂ ≈	r _{1,2} min.	d _a min.	d _a max.	D _a max.	r _a max.	k _r	f ₀	
mm						mm				-		
3	5,2	-	-	8,2	0,15	4,2	-	8,8	0,1	0,025	7,5	
	5,2	-	-	8,2	0,15	4,2	5,1	8,8	0,1	0,025	7,5	
	5,2	-	-	8,2	0,15	4,2	5,1	8,8	0,1	0,025	7,5	
4	5,2	-	7,5	-	0,1	4,6	-	8,4	0,1	0,015	6,5	
	5,2	-	-	8,1	0,1	4,6	5,1	8,4	0,1	0,015	10	
	5,2	-	-	8,1	0,1	4,6	5,1	8,4	0,1	0,015	10	
	6,1	-	-	9,9	0,15	4,8	5,8	10,2	0,1	0,02	6,4	
	6,1	-	-	9,9	0,15	4,8	-	10,2	0,1	0,02	6,4	
	6,1	-	-	9,8	0,2	5,4	-	10,6	0,2	0,025	10	
	6,1	-	-	9,8	0,2	5,4	6	10,6	0,2	0,025	10	
	6,7	-	-	11,2	0,2	5,8	-	11,2	0,2	0,025	10	
	6,7	-	-	11,2	0,2	5,8	6,6	11,2	0,2	0,025	7,3	
	8,4	-	-	13,3	0,3	6,4	-	13,6	0,3	0,03	8,4	
	8,4	-	-	13,3	0,3	6,4	8,3	13,6	0,3	0,03	8,4	
	8,4	-	-	13,3	0,3	6,4	8,3	13,6	0,3	0,03	8,4	
	8,4	-	-	13,3	0,3	6,4	8,3	13,6	0,3	0,03	8,4	
	5	6,8	-	9,2	-	0,15	5,8	-	10,2	0,1	0,015	7,1
		6,8	-	-	9,9	0,15	5,8	6,7	10,2	0,1	0,015	11
-		6,2	-	9,9	0,15	5,8	6	10,2	0,1	0,015	11	
7,5		-	-	11,2	0,2	6,4	7,5	11,6	0,2	0,02	11	
7,5		-	-	11,2	0,2	6,4	-	11,6	0,2	0,02	11	
8,4		-	-	13,3	0,3	7,4	-	13,6	0,3	0,025	8,4	
8,4		-	-	13,3	0,3	7,4	8,3	13,6	0,3	0,025	8,4	
11,1		-	-	16,5	0,3	7,4	-	16,6	0,3	0,03	13	
11,1		-	-	16,5	0,3	7,4	10,6	16,6	0,3	0,03	13	
11,1		-	-	16,5	0,3	7,4	10,6	16,6	0,3	0,03	13	
11,1		-	-	16,5	0,3	7,4	10,6	16,6	0,3	0,03	13	
6		8	-	11	-	0,15	6,8	-	12,2	0,1	0,015	7
		-	7,4	-	11,7	0,15	6,8	7,2	12,2	0,1	0,015	11
		8,2	-	-	13	0,2	7,4	8	13,6	0,2	0,02	6,8
		8,2	-	-	13	0,2	7,4	-	13,6	0,2	0,02	6,8
	11,1	-	-	16,5	0,3	8,4	-	16,6	0,3	0,025	13	
	-	9,5	-	16,5	0,3	8,4	9,4	16,6	0,3	0,025	13	
	-	9,5	-	16,5	0,3	8,4	9,4	16,6	0,3	0,025	13	
	11,1	-	-	16,5	0,3	8,4	11	16,6	0,3	0,025	13	
	11,1	-	-	16,5	0,3	8,4	11	16,6	0,3	0,025	13	
	11,1	-	-	16,5	0,3	8,4	11	16,6	0,3	0,025	13	

1.1 Single row deep groove ball bearings

d 7 – 9 mm

1.1

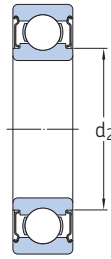
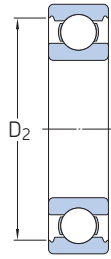
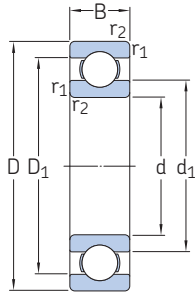

ZZ



2RS



2RZ



2RS1



2RS1



2RSH

ZZ

Principal dimensions			Basic load ratings		Fatigue load limit	Speed ratings		Mass	Designations		
d	D	B	C	C ₀	P _u	Reference speed	Limiting speed ¹⁾		Bearing open or capped on both sides	capped on one side ¹⁾	
mm			kN		kN	r/min		kg	–		
7	14	3,5	0,78	0,26	0,011	100 000	63 000	0,0022	618/7	–	
	14	5	0,956	0,4	0,017	100 000	50 000	0,0031	628/7-2Z	–	
	17	5	1,06	0,375	0,016	90 000	45 000	0,0049	619/7-2Z	–	
	17	5	1,06	0,375	0,016	90 000	56 000	0,0049	619/7	–	
	19	6	2,34	0,95	0,04	85 000	53 000	0,0076	▶ 607	–	
	19	6	2,34	0,95	0,04	–	24 000	0,0078	▶ 607-2RSH	607-RSH	
	19	6	2,34	0,95	0,04	85 000	43 000	0,0078	▶ 607-2RSL	607-RSL	
	19	6	2,34	0,95	0,04	85 000	43 000	0,0084	▶ 607-2Z	607-Z	
	22	7	3,45	1,37	0,057	70 000	45 000	0,012	▶ 627	–	
	22	7	3,45	1,37	0,057	–	22 000	0,013	▶ 627-2RSH	627-RSH	
	22	7	3,45	1,37	0,057	70 000	36 000	0,013	▶ 627-2RSL	627-RSL	
	22	7	3,45	1,37	0,057	70 000	36 000	0,013	▶ 627-2Z	627-Z	
	8	16	4	0,819	0,3	0,012	90 000	56 000	0,003	618/8	–
		16	5	1,33	0,57	0,024	–	26 000	0,0036	▶ 628/8-2RS1	–
		16	5	1,33	0,57	0,024	90 000	45 000	0,0036	▶ 628/8-2Z	–
16		6	1,33	0,57	0,024	90 000	45 000	0,0043	638/8-2Z	–	
19		6	1,46	0,465	0,02	–	24 000	0,0071	619/8-2RS1	–	
19		6	1,46	0,465	0,02	85 000	43 000	0,0071	619/8-2Z	–	
19		6	1,46	0,465	0,02	85 000	53 000	0,0071	619/8	–	
19		6	2,34	0,95	0,04	85 000	43 000	0,0072	607/8-2Z	607/8-Z	
22		7	3,45	1,37	0,057	75 000	48 000	0,012	▶ 608	–	
22		7	3,45	1,37	0,057	–	22 000	0,012	▶ 608-2RSH	▶ 608-RSH	
22		7	3,45	1,37	0,057	75 000	38 000	0,012	▶ 608-2RSL	608-RSL	
22		7	3,45	1,37	0,057	75 000	38 000	0,013	▶ 608-2Z	608-Z	
22		11	3,45	1,37	0,057	–	22 000	0,016	▶ 630/8-2RS1	–	
24		8	3,9	1,66	0,071	63 000	40 000	0,018	628	–	
24		8	3,9	1,66	0,071	–	19 000	0,017	628-2RS1	628-RS1	
24		8	3,9	1,66	0,071	63 000	32 000	0,017	628-2RZ	628-RZ	
24		8	3,9	1,66	0,071	63 000	32 000	0,018	▶ 628-2Z	628-Z	
28		9	1,33	0,57	0,024	60 000	30 000	0,03	638-2RZ	638-RZ	
9	17	4	0,871	0,34	0,014	85 000	53 000	0,0034	618/9	–	
	17	5	1,43	0,64	0,027	–	24 000	0,0043	628/9-2RS1	–	
	17	5	1,43	0,64	0,027	85 000	43 000	0,0043	628/9-2Z	628/9-Z	
	20	6	2,34	0,98	0,043	80 000	40 000	0,0076	619/9-2Z	–	
	20	6	2,34	0,98	0,043	80 000	50 000	0,0076	619/9	–	
	24	7	3,9	1,66	0,071	70 000	43 000	0,014	▶ 609	–	

SKF Explorer bearing

▶ Popular item

¹⁾ For bearings with only one shield or one non-contact seal (Z, RZ) the limiting speeds of the open bearings are valid.

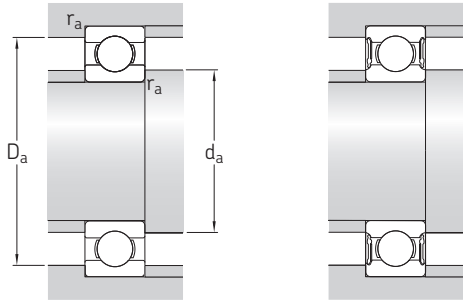

Dimensions						Abutment and fillet dimensions				Calculation factors		
d	d ₁ ≈	d ₂ ≈	D ₁ ≈	D ₂ ≈	r _{1,2} min.	d _a min.	d _a max.	D _a max.	r _a max.	k _r	f ₀	
mm						mm				–		
7	9	–	12	–	0,15	7,8	–	13,2	0,1	0,015	7,2	
	–	8,5	–	12,7	0,15	7,8	8	13,2	0,1	0,015	11	
	10,4	–	–	14,3	0,3	9	9,7	15	0,3	0,02	7,3	
	10,4	–	–	14,3	0,3	9	–	15	0,3	0,02	7,3	
	11,1	–	–	16,5	0,3	9	–	17	0,3	0,025	13	
	–	9,5	–	16,5	0,3	9	9,4	17	0,3	0,025	13	
	–	9,5	–	16,5	0,3	9	9,4	17	0,3	0,025	13	
	11,1	–	–	16,5	0,3	9	11	17	0,3	0,025	13	
	12,1	–	–	19,2	0,3	9,4	–	19,6	0,3	0,025	12	
	–	10,5	–	19,2	0,3	9,4	10,5	19,6	0,3	0,025	12	
	–	10,5	–	19,2	0,3	9,4	10,5	19,6	0,3	0,025	12	
	12,1	–	–	19,2	0,3	9,4	12,1	19,6	0,3	0,025	12	
	8	10,5	–	13,5	–	0,2	9,4	–	14,6	0,2	0,015	7,5
		10,1	–	–	14,2	0,2	9,4	9,4	14,6	0,2	0,015	11
10,1		–	–	14,2	0,2	9,4	10	14,6	0,2	0,015	11	
–		9,6	–	14,2	0,2	9,4	9,5	14,6	0,2	0,015	11	
–		9,8	–	16,7	0,3	9,5	9,8	17	0,3	0,02	6,6	
–		9,8	–	16,7	0,3	9,5	9,8	17	0,3	0,02	6,6	
10,5		–	–	16,7	0,3	10	–	17	0,3	0,02	6,6	
11,1		–	–	16,5	0,3	10	11	17	0,3	0,025	13	
12,1		–	–	19,2	0,3	10	–	20	0,3	0,025	12	
–		10,5	–	19,2	0,3	10	10,5	20	0,3	0,025	12	
–		10,5	–	19,2	0,3	10	10,5	20	0,3	0,025	12	
12,1		–	–	19,2	0,3	10	12	20	0,3	0,025	12	
11,8		–	–	19	0,3	10	11,7	20	0,3	0,025	12	
14,4		–	–	21,2	0,3	10,4	–	21,6	0,3	0,025	13	
14,4		–	–	21,2	0,3	10,4	14,4	21,6	0,3	0,025	13	
14,4		–	–	21,2	0,3	10,4	14,4	21,6	0,3	0,025	13	
14,4		–	–	21,2	0,3	10,4	14,4	21,6	0,3	0,025	13	
14,8		–	–	22,6	0,3	10,4	14,7	25,6	0,3	0,03	12	
9		11,5	–	14,5	–	0,2	10,4	–	15,6	0,2	0,015	7,7
		–	10,7	–	15,2	0,2	10,4	10,5	15,6	0,2	0,015	11
	–	10,7	–	15,2	0,2	10,4	10,5	15,6	0,2	0,015	11	
	11,6	–	–	17,5	0,3	11	11,5	18	0,3	0,02	12	
	11,6	–	–	17,5	0,3	11	–	18	0,3	0,02	12	
	14,4	–	–	21,2	0,3	11	–	22	0,3	0,025	13	

1.1 Single row deep groove ball bearings

d 9 – 10 mm

1.1

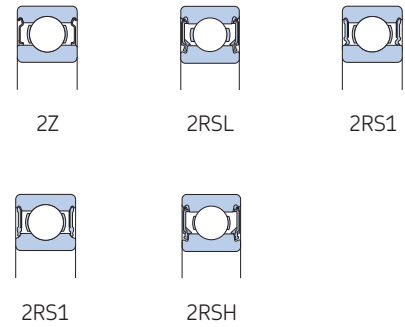
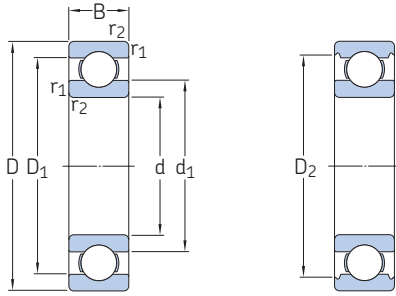

Principal dimensions			Basic load ratings		Fatigue load limit	Speed ratings		Mass	Designations	
d	D	B	C	C ₀	P _u	Reference speed	Limiting speed ¹⁾		Bearing open or capped on both sides	capped on one side ¹⁾
mm			kN		kN	r/min		kg	–	
9 cont.	24	7	3,9	1,66	0,071	–	19 000	0,015	▶ 609-2RSH	609-RSH
	24	7	3,9	1,66	0,071	70 000	34 000	0,014	▶ 609-2RSL	609-RSL
	24	7	3,9	1,66	0,071	70 000	34 000	0,015	▶ 609-2Z	609-Z
	26	8	4,75	1,96	0,083	60 000	38 000	0,02	▶ 629	–
	26	8	4,75	1,96	0,083	–	19 000	0,02	▶ 629-2RSH	629-RSH
	26	8	4,75	1,96	0,083	60 000	30 000	0,02	▶ 629-2RSL	629-RSL
	26	8	4,75	1,96	0,083	60 000	30 000	0,021	▶ 629-2Z	629-Z
10	19	5	1,72	0,83	0,036	–	22 000	0,0055	61800-2RS1	–
	19	5	1,72	0,83	0,036	80 000	38 000	0,0055	61800-2Z	–
	19	5	1,72	0,83	0,036	80 000	48 000	0,0053	61800	–
	22	6	2,7	1,27	0,054	–	20 000	0,01	61900-2RS1	–
	22	6	2,7	1,27	0,054	70 000	36 000	0,01	61900-2Z	–
	22	6	2,7	1,27	0,054	70 000	45 000	0,01	61900	–
	26	8	4,75	1,96	0,083	67 000	40 000	0,019	▶ 6000	–
	26	8	4,75	1,96	0,083	–	19 000	0,019	▶ 6000-2RSH	6000-RSH
	26	8	4,75	1,96	0,083	67 000	34 000	0,019	▶ 6000-2RSL	6000-RSL
	26	8	4,75	1,96	0,083	67 000	34 000	0,02	▶ 6000-2Z	▶ 6000-Z
	26	12	4,62	1,96	0,083	–	19 000	0,025	63000-2RS1	–
	28	8	5,07	2,36	0,1	60 000	30 000	0,026	16100-2Z	–
	28	8	5,07	2,36	0,1	60 000	38 000	0,024	16100	–
	30	9	5,4	2,36	0,1	56 000	36 000	0,031	▶ 6200	–
	30	9	5,4	2,36	0,1	–	17 000	0,032	▶ 6200-2RSH	6200-RSH
	30	9	5,4	2,36	0,1	56 000	28 000	0,032	▶ 6200-2RSL	6200-RSL
	30	9	5,4	2,36	0,1	56 000	28 000	0,034	▶ 6200-2Z	6200-Z
	30	14	5,07	2,36	0,1	–	17 000	0,04	62200-2RS1	–
	35	11	8,52	3,4	0,143	50 000	32 000	0,053	▶ 6300	–
	35	11	8,52	3,4	0,143	–	15 000	0,054	▶ 6300-2RSH	6300-RSH
35	11	8,52	3,4	0,143	50 000	26 000	0,053	6300-2RSL	6300-RSL	
35	11	8,52	3,4	0,143	50 000	26 000	0,055	▶ 6300-2Z	6300-Z	
35	17	8,06	3,4	0,143	–	15 000	0,06	62300-2RS1	–	

SKF Explorer bearing

▶ Popular item

¹⁾ For bearings with only one shield or one non-contact seal (Z, RZ) the limiting speeds of the open bearings are valid.

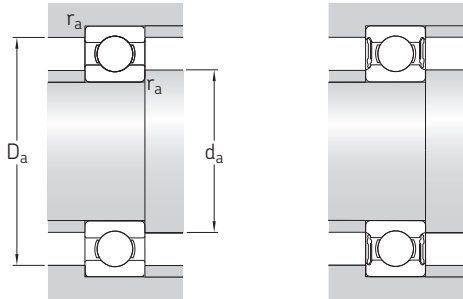

Dimensions						Abutment and fillet dimensions				Calculation factors	
d	d ₁ ≈	d ₂ ≈	D ₁ ≈	D ₂ ≈	r _{1,2} min.	d _a min.	d _a max.	D _a max.	r _a max.	k _r	f ₀
mm						mm				–	
9 cont.	–	12,8	–	21,2	0,3	11	12,5	22	0,3	0,025	13
	–	12,8	–	21,2	0,3	11	12,5	22	0,3	0,025	13
	14,4	–	–	21,2	0,3	11	14,3	22	0,3	0,025	13
	14,8	–	–	22,6	0,3	11,4	–	23,6	0,3	0,025	12
10	–	12,5	–	22,6	0,3	11,4	12,5	23,6	0,3	0,025	12
	–	12,5	–	22,6	0,3	11,4	12,5	23,6	0,3	0,025	12
	14,8	–	–	22,6	0,3	11,4	14,7	23,6	0,3	0,025	12
	–	11,8	–	17,2	0,3	11,8	11,8	17	0,3	0,015	15
	12,7	–	–	17,2	0,3	12	12,5	17	0,3	0,015	15
	12,7	–	16,3	–	0,3	12	–	17	0,3	0,015	15
	–	13,2	–	19,4	0,3	12	12	20	0,3	0,02	14
	13,9	–	–	19,4	0,3	12	12,9	20	0,3	0,02	14
	13,9	–	18,2	–	0,3	12	–	20	0,3	0,02	14
	14,8	–	–	22,6	0,3	12	–	24	0,3	0,025	12
	–	12,5	–	22,6	0,3	12	12,5	24	0,3	0,025	12
	–	12,5	–	22,6	0,3	12	12,5	24	0,3	0,025	12
	14,8	–	–	22,6	0,3	12	14,7	24	0,3	0,025	12
	14,8	–	–	22,6	0,3	12	14,7	24	0,3	0,025	12
	17	–	–	24,8	0,3	14,2	16,6	23,8	0,3	0,025	13
	17	–	–	24,8	0,3	14,2	–	23,8	0,3	0,025	13
17	–	–	24,8	0,6	14,2	–	25,8	0,6	0,025	13	
–	15	–	24,8	0,6	14,2	15	25,8	0,6	0,025	13	
–	15	–	24,8	0,6	14,2	15	25,8	0,6	0,025	13	
17	–	–	24,8	0,6	14,2	16,9	25,8	0,6	0,025	13	
17	–	–	24,8	0,6	14,2	16,9	25,8	0,6	0,025	13	
17,5	–	–	28,7	0,6	14,2	–	30,8	0,6	0,03	11	
–	15,5	–	28,7	0,6	14,2	15,5	30,8	0,6	0,03	11	
–	15,5	–	28,7	0,6	14,2	15,5	30,8	0,6	0,03	11	
17,5	–	–	28,7	0,6	14,2	17,4	30,8	0,6	0,03	11	
17,5	–	–	28,7	0,6	14,2	17,4	30,8	0,6	0,03	11	

1.1 Single row deep groove ball bearings

d 12 – 15 mm

1.1

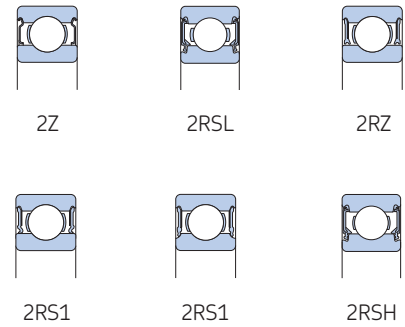
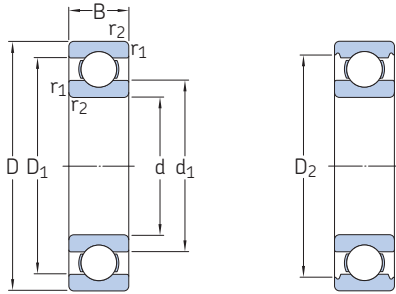

Principal dimensions			Basic load ratings		Fatigue load limit	Speed ratings		Mass	Designations	
d	D	B	C	C ₀		Reference speed	Limiting speed ¹⁾		Bearing open or capped on both sides	capped on one side ¹⁾
mm			kN		kN	r/min		kg	–	
12	21	5	1,74	0,915	0,039	–	20 000	0,0063	▶ 61801-2RS1	–
	21	5	1,74	0,915	0,039	70 000	36 000	0,0063	▶ 61801-2Z	–
	21	5	1,74	0,915	0,039	70 000	43 000	0,0063	▶ 61801	–
	24	6	2,91	1,46	0,062	–	19 000	0,011	▶ 61901-2RS1	–
	24	6	2,91	1,46	0,062	67 000	32 000	0,011	▶ 61901-2Z	–
	24	6	2,91	1,46	0,062	67 000	40 000	0,011	▶ 61901	–
	28	8	5,4	2,36	0,1	60 000	38 000	0,021	▶ 6001	–
	28	8	5,4	2,36	0,1	–	17 000	0,022	▶ 6001-2RSH	6001-RSH
	28	8	5,4	2,36	0,1	60 000	30 000	0,021	▶ 6001-2RSL	6001-RSL
	28	8	5,4	2,36	0,1	60 000	30 000	0,022	▶ 6001-2Z	6001-Z
	28	12	5,07	2,36	0,1	–	17 000	0,029	63001-2RS1	–
	30	8	5,07	2,36	0,1	–	17 000	0,028	16101-2RS1	–
	30	8	5,07	2,36	0,1	56 000	28 000	0,028	16101-2Z	–
	30	8	5,07	2,36	0,1	60 000	38 000	0,026	16101	–
	32	10	7,28	3,1	0,132	50 000	32 000	0,037	▶ 6201	–
	32	10	7,28	3,1	0,132	–	15 000	0,038	▶ 6201-2RSH	6201-RSH
	32	10	7,28	3,1	0,132	50 000	26 000	0,038	▶ 6201-2RSL	6201-RSL
	32	10	7,28	3,1	0,132	50 000	26 000	0,039	▶ 6201-2Z	6201-Z
32	14	6,89	3,1	0,132	–	15 000	0,045	62201-2RS1	–	
37	12	10,1	4,15	0,176	45 000	28 000	0,06	▶ 6301	–	
37	12	10,1	4,15	0,176	–	14 000	0,062	▶ 6301-2RSH	6301-RSH	
37	12	10,1	4,15	0,176	45 000	22 000	0,06	6301-2RSL	6301-RSL	
37	12	10,1	4,15	0,176	45 000	22 000	0,063	▶ 6301-2Z	6301-Z	
37	17	9,75	4,15	0,176	–	14 000	0,07	62301-2RS1	–	
15	24	5	1,9	1,1	0,048	–	17 000	0,0074	▶ 61802-2RS1	–
	24	5	1,9	1,1	0,048	60 000	30 000	0,0074	▶ 61802-2Z	–
	24	5	1,9	1,1	0,048	60 000	38 000	0,0065	▶ 61802	–
	28	7	4,36	2,24	0,095	–	16 000	0,016	▶ 61902-2RS1	–
	28	7	4,36	2,24	0,095	56 000	28 000	0,016	▶ 61902-2RZ	–
	28	7	4,36	2,24	0,095	56 000	28 000	0,016	▶ 61902-2Z	–
	28	7	4,36	2,24	0,095	56 000	34 000	0,016	▶ 61902	–
	32	8	5,85	2,85	0,12	50 000	32 000	0,027	▶ 16002	–
	32	8	5,85	2,85	0,12	50 000	26 000	0,025	▶ 16002-2Z	16002-Z
	32	9	5,85	2,85	0,12	50 000	32 000	0,03	▶ 6002	–
	32	9	5,85	2,85	0,12	–	14 000	0,03	▶ 6002-2RSH	6002-RSH
	32	9	5,85	2,85	0,12	50 000	26 000	0,03	▶ 6002-2RSL	6002-RSL

SKF Explorer bearing

▶ Popular item

¹⁾ For bearings with only one shield or one non-contact seal (Z, RZ) the limiting speeds of the open bearings are valid.

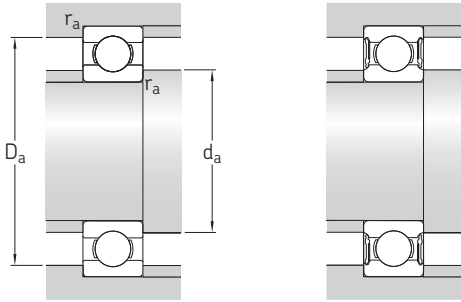

Dimensions						Abutment and fillet dimensions				Calculation factors	
d	d ₁ ≈	d ₂ ≈	D ₁ ≈	D ₂ ≈	r _{1,2} min.	d _a min.	d _a max.	D _a max.	r _a max.	k _r	f ₀
mm						mm				–	
12	–	14,1	–	19	0,3	13,6	13,8	19	0,3	0,015	13
	14,8	–	–	19	0,3	14	14,7	19	0,3	0,015	13
	14,8	–	18,3	–	0,3	14	–	19	0,3	0,015	13
	–	15,3	–	21,4	0,3	14	15,2	22	0,3	0,02	15
	16	–	–	21,4	0,3	14	15,8	22	0,3	0,02	15
	16	–	20,3	–	0,3	14	–	22	0,3	0,02	15
	17	–	–	24,8	0,3	14	–	26	0,3	0,025	13
	–	14,7	–	24,8	0,3	14	15	26	0,3	0,025	13
	–	14,7	–	24,8	0,3	14	15	26	0,3	0,025	13
	17	–	–	24,8	0,3	14	16,9	26	0,3	0,025	13
	17	–	–	24,8	0,3	14	16,9	26	0,3	0,025	13
	17	–	–	24,8	0,3	14,4	16,6	27,6	0,3	0,025	13
	17	–	–	24,8	0,3	14,4	16,6	27,6	0,3	0,025	13
	17	–	–	24,8	0,3	14,4	–	27,6	0,3	0,025	13
	18,4	–	–	27,4	0,6	16,2	–	27,8	0,6	0,025	12
	–	16,2	–	27,4	0,6	16,2	16,5	27,8	0,6	0,025	12
	–	16,2	–	27,4	0,6	16,2	16,5	27,8	0,6	0,025	12
	18,4	–	–	27,4	0,6	16,2	18,4	27,8	0,6	0,025	12
18,5	–	–	27,4	0,6	16,2	18,4	27,8	0,6	0,025	12	
19,5	–	–	31,5	1	17,6	–	31,4	1	0,03	11	
–	17,5	–	31,5	1	17,6	17,8	31,4	1	0,03	11	
–	17,5	–	31,5	1	17,6	17,6	31,4	1	0,03	11	
19,5	–	–	31,5	1	17,6	19,4	31,4	1	0,03	11	
19,5	–	–	31,5	1	17,6	19,4	31,4	1	0,03	11	
15	17,8	–	–	22,2	0,3	17	17,8	22	0,3	0,015	14
	17,8	–	–	22,2	0,3	17	17,8	22	0,3	0,015	14
	17,8	–	21,3	–	0,3	17	–	22	0,3	0,015	14
	18,8	–	–	25,3	0,3	17	18,3	26	0,3	0,02	14
	18,8	–	–	25,3	0,3	17	18,3	26	0,3	0,02	14
	18,8	–	–	25,3	0,3	17	18,3	26	0,3	0,02	14
	18,8	–	–	25,3	0,3	17	–	26	0,3	0,02	14
	20,5	–	–	28,2	0,3	17	–	30	0,3	0,02	14
	20,5	–	–	28,2	0,3	17	20,1	30	0,3	0,02	14
	20,5	–	–	28,2	0,3	17	–	30	0,3	0,025	14
	–	18,3	–	28,2	0,3	17	18,5	30	0,3	0,025	14
	–	18,3	–	28,2	0,3	17	18,5	30	0,3	0,025	14

1.1 Single row deep groove ball bearings

d 15 – 17 mm

1.1

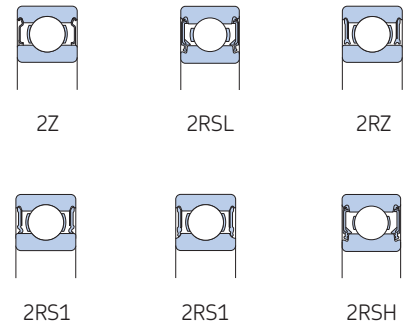
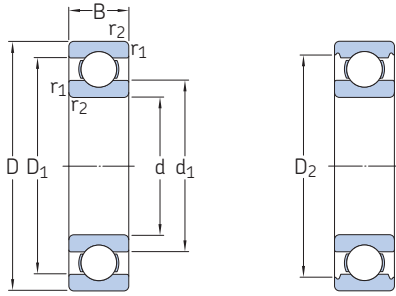

Principal dimensions			Basic load ratings		Fatigue load limit	Speed ratings		Mass	Designations	
d	D	B	dynamic	static		Reference speed	Limiting speed ¹⁾		Bearing open or capped on both sides	capped on one side ¹⁾
mm			kN		kN	r/min		kg	–	
15 cont.	32	9	5,85	2,85	0,12	50 000	26 000	0,032	▶ 6002-Z	6002-Z
	32	13	5,59	2,85	0,12	–	14 000	0,039	▶ 63002-2RS1	–
	35	11	8,06	3,75	0,16	43 000	28 000	0,045	▶ 6202	–
	35	11	8,06	3,75	0,16	–	13 000	0,046	▶ 6202-2RSH	6202-RSH
	35	11	8,06	3,75	0,16	43 000	22 000	0,046	▶ 6202-2RSL	6202-RSL
	35	11	8,06	3,75	0,16	43 000	22 000	0,048	▶ 6202-Z	6202-Z
	35	14	7,8	3,75	0,16	–	13 000	0,054	▶ 62202-2RS1	–
	42	13	11,9	5,4	0,228	38 000	24 000	0,082	▶ 6302	–
	42	13	11,9	5,4	0,228	–	12 000	0,085	▶ 6302-2RSH	6302-RSH
	42	13	11,9	5,4	0,228	38 000	19 000	0,085	▶ 6302-2RSL	6302-RSL
42	13	11,9	5,4	0,228	38 000	19 000	0,086	▶ 6302-Z	6302-Z	
42	17	11,4	5,4	0,228	–	12 000	0,11	▶ 62302-2RS1	–	
52	7	4,49	3,75	0,16	–	7 500	0,034	▶ 61808-2RS1	–	
17	26	5	2,03	1,27	0,054	–	16 000	0,0082	▶ 61803-2RS1	–
	26	5	2,03	1,27	0,054	56 000	28 000	0,0082	▶ 61803-2RZ	–
	26	5	2,03	1,27	0,054	56 000	28 000	0,0082	▶ 61803-Z	–
	26	5	2,03	1,27	0,054	56 000	34 000	0,0075	▶ 61803	–
	30	7	4,62	2,55	0,108	–	14 000	0,017	▶ 61903-2RS1	–
	30	7	4,62	2,55	0,108	50 000	26 000	0,017	▶ 61903-Z	–
	30	7	4,62	2,55	0,108	50 000	26 000	0,018	▶ 61903-2RZ	–
	30	7	4,62	2,55	0,108	50 000	32 000	0,016	▶ 61903	–
	35	8	6,37	3,25	0,137	45 000	22 000	0,032	▶ 16003-Z	–
	35	8	6,37	3,25	0,137	45 000	28 000	0,031	▶ 16003	–
	35	10	6,37	3,25	0,137	45 000	28 000	0,038	▶ 6003	–
	35	10	6,37	3,25	0,137	–	13 000	0,039	▶ 6003-2RSH	6003-RSH
	35	10	6,37	3,25	0,137	45 000	22 000	0,039	▶ 6003-2RSL	6003-RSL
	35	10	6,37	3,25	0,137	45 000	22 000	0,041	▶ 6003-Z	6003-Z
	35	14	6,05	3,25	0,137	–	13 000	0,052	▶ 63003-2RS1	–
	40	12	9,95	4,75	0,2	38 000	24 000	0,065	▶ 6203	–
	40	12	9,95	4,75	0,2	–	12 000	0,067	▶ 6203-2RSH	6203-RSH
40	12	9,95	4,75	0,2	38 000	19 000	0,067	▶ 6203-2RSL	6203-RSL	
40	12	9,95	4,75	0,2	38 000	19 000	0,068	▶ 6203-Z	6203-Z	
40	12	11,4	5,4	0,228	38 000	24 000	0,064	▶ 6203 ETN9	–	
40	16	9,56	4,75	0,2	–	12 000	0,089	▶ 62203-2RS1	–	

SKF Explorer bearing

▶ Popular item

¹⁾ For bearings with only one shield or one non-contact seal (Z, RZ) the limiting speeds of the open bearings are valid.

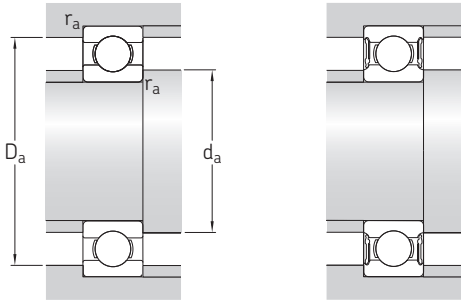

Dimensions						Abutment and fillet dimensions				Calculation factors	
d	d ₁ ≈	d ₂ ≈	D ₁ ≈	D ₂ ≈	r _{1,2} min.	d _a min.	d _a max.	D _a max.	r _a max.	k _r	f ₀
mm						mm				–	
15 cont.	20,5	–	–	28,2	0,3	17	20,4	30	0,3	0,025	14
	20,5	–	–	28,2	0,3	17	20,4	30	0,3	0,025	14
	21,7	–	–	30,5	0,6	19,2	–	30,8	0,6	0,025	13
	–	18,6	–	30,5	0,6	19,2	19,4	31,3	0,6	0,025	13
	–	18,6	–	30,5	0,6	19,2	19,4	30,8	0,6	0,025	13
	21,7	–	–	30,5	0,6	19,2	21,6	30,8	0,6	0,025	13
	21,7	–	–	30,4	0,6	19,2	21,6	30,8	0,6	0,025	13
	23,7	–	–	36,3	1	20,6	–	36,4	1	0,03	12
	–	20,6	–	36,3	1	20,6	21	36,4	1	0,03	12
	–	20,6	–	36,3	1	20,6	21	36,4	1	0,03	12
	23,7	–	–	36,3	1	20,6	23,6	36,4	1	0,03	12
	23,7	–	–	36,3	1	20,6	23,6	36,4	1	0,03	12
–	42,1	–	49,3	0,3	42	42	50	0,3	0,015	15	
17	19,8	–	–	24,2	0,3	18	18,6	24	0,3	0,015	14
	19,8	–	–	24,2	0,3	19	19,6	24	0,3	0,015	14
	19,8	–	–	24,2	0,3	19	19,6	24	0,3	0,015	14
	19,8	–	23,3	–	0,3	19	–	24	0,3	0,015	14
	–	19,4	–	27,7	0,3	19	19,3	28	0,3	0,02	15
	20,4	–	–	27,7	0,3	19	20,3	28	0,3	0,02	15
	20,4	–	–	27,7	0,3	19	20,3	28	0,3	0,02	15
	20,4	–	–	27,7	0,3	19	–	28	0,3	0,02	15
	23	–	–	31,2	0,3	19	22,6	33	0,3	0,02	14
	23	–	–	31,2	0,3	19	–	33	0,3	0,02	14
	23	–	–	31,2	0,3	19	–	33	0,3	0,025	14
	–	20,4	–	31,2	0,3	19	20,5	33	0,3	0,025	14
	–	20,4	–	31,2	0,3	19	20,5	33	0,3	0,025	14
	23	–	–	31,2	0,3	19	22,9	33	0,3	0,025	14
	23	–	–	31,2	0,3	19	22,9	33	0,3	0,025	14
	24,5	–	–	35	0,6	21,2	–	35,8	0,6	0,025	13
	–	21,7	–	35	0,6	21,2	22	35,8	0,6	0,025	13
	–	21,7	–	35	0,6	21,2	22	35,8	0,6	0,025	13
24,5	–	–	35	0,6	21,2	24,4	35,8	0,6	0,025	13	
24,5	–	–	32,7	0,6	21,2	–	35,8	0,6	0,03	12	
–	21,5	–	35	0,6	21,2	24,4	35,8	0,6	0,025	13	

1.1 Single row deep groove ball bearings

d 17 – 22 mm

1.1

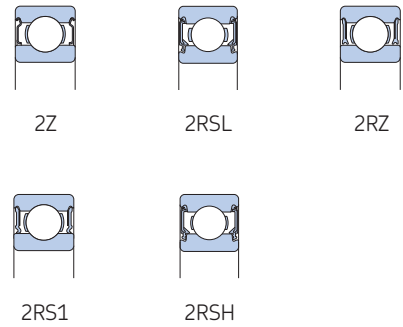
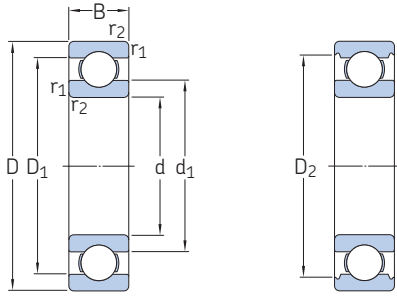

Principal dimensions			Basic load ratings		Fatigue load limit	Speed ratings		Mass	Designations	
d	D	B	C	C ₀		Reference speed	Limiting speed ¹⁾		Bearing open or capped on both sides	capped on one side ¹⁾
mm			kN		kN	r/min	kg	–		
17 cont.	47	14	14,3	6,55	0,275	34 000	22 000	0,11	▶ 6303	–
	47	14	14,3	6,55	0,275	–	11 000	0,12	▶ 6303-2RSH	6303-RSH
	47	14	14,3	6,55	0,275	34 000	17 000	0,12	▶ 6303-2RSL	6303-RSL
	47	14	14,3	6,55	0,275	34 000	17 000	0,12	▶ 6303-2Z	6303-Z
	47	19	13,5	6,55	0,275	–	11 000	0,16	62303-2RS1	–
	62	17	22,9	10,8	0,455	28 000	18 000	0,27	6403	–
20	32	7	4,03	2,32	0,104	–	13 000	0,018	▶ 61804-2RS1	–
	32	7	4,03	2,32	0,104	45 000	22 000	0,018	▶ 61804-2RZ	–
	32	7	4,03	2,32	0,104	45 000	28 000	0,018	▶ 61804	–
	37	9	6,37	3,65	0,156	–	12 000	0,038	▶ 61904-2RS1	–
	37	9	6,37	3,65	0,156	43 000	20 000	0,038	▶ 61904-2RZ	–
	37	9	6,37	3,65	0,156	43 000	26 000	0,037	▶ 61904	–
	42	8	7,28	4,05	0,173	38 000	24 000	0,051	▶ 16004	–
	42	12	9,95	5	0,212	38 000	24 000	0,067	▶ 6004	–
	42	12	9,95	5	0,212	–	11 000	0,067	▶ 6004-2RSH	6004-RSH
	42	12	9,95	5	0,212	38 000	19 000	0,069	▶ 6004-2RSL	6004-RSL
	42	12	9,95	5	0,212	38 000	19 000	0,071	▶ 6004-2Z	6004-Z
	42	16	9,36	5	0,212	–	11 000	0,086	63004-2RS1	–
	47	14	13,5	6,55	0,28	32 000	20 000	0,11	▶ 6204	–
	47	14	13,5	6,55	0,28	–	10 000	0,11	▶ 6204-2RSH	6204-RSH
	47	14	13,5	6,55	0,28	32 000	17 000	0,11	▶ 6204-2RSL	6204-RSL
	47	14	13,5	6,55	0,28	32 000	17 000	0,11	▶ 6204-2Z	6204-Z
	47	14	15,6	7,65	0,325	32 000	20 000	0,098	6204 ETN9	–
	47	18	12,7	6,55	0,28	–	10 000	0,13	62204-2RS1	–
	52	15	15,9	7,8	0,335	30 000	15 000	0,15	▶ 6304-2RSL	6304-RSL
	52	15	16,8	7,8	0,335	30 000	19 000	0,14	▶ 6304	–
	52	15	16,8	7,8	0,335	–	9 500	0,15	▶ 6304-2RSH	6304-RSH
52	15	16,8	7,8	0,335	30 000	15 000	0,15	▶ 6304-2Z	6304-Z	
52	15	18,2	9	0,38	30 000	19 000	0,14	6304 ETN9	–	
52	21	15,9	7,8	0,335	–	9 500	0,21	62304-2RS1	–	
72	19	30,7	15	0,64	24 000	15 000	0,41	6404	–	
22	50	14	14	7,65	0,325	–	9 000	0,12	62/22-2RS1	–
	50	14	14	7,65	0,325	30 000	19 000	0,12	62/22	–
	56	16	18,6	9,3	0,39	28 000	18 000	0,18	63/22	–

SKF Explorer bearing

▶ Popular item

¹⁾ For bearings with only one shield or one non-contact seal (Z, RZ) the limiting speeds of the open bearings are valid.

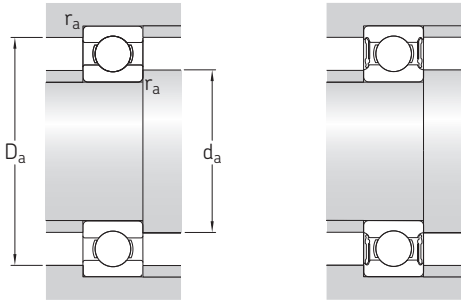

Dimensions						Abutment and fillet dimensions				Calculation factors	
d	d ₁ ≈	d ₂ ≈	D ₁ ≈	D ₂ ≈	r _{1,2} min.	d _a min.	d _a max.	D _a max.	r _a max.	k _r	f ₀
mm						mm				-	
17 cont.	26,5	-	-	39,6	1	22,6	-	41,4	1	0,03	12
	-	23,4	-	39,6	1	22,6	23,5	41,4	1	0,03	12
	-	23,4	-	39,6	1	22,6	23,5	41,4	1	0,03	12
	26,5	-	-	39,6	1	22,6	26,4	41,4	1	0,03	12
	26,5	-	-	39,6	1	22,6	26,4	41,4	1	0,03	12
	32,4	-	-	48,7	1,1	23,5	-	55	1	0,035	11
20	23,8	-	-	29,4	0,6	22	23,6	30	0,3	0,015	15
	23,8	-	-	29,4	0,6	22	23,6	30	0,3	0,015	15
	23,8	-	28,3	-	0,3	22	-	30	0,3	0,015	15
	25,5	-	-	32,7	0,3	22	23	35	0,3	0,02	15
	25,5	-	-	32,7	0,3	22	25,5	35	0,3	0,02	15
	25,5	-	-	32,7	0,3	22	-	35	0,3	0,02	15
	27,2	-	-	37,2	0,3	22	-	40	0,3	0,02	15
	27,2	-	-	37,2	0,6	23,2	-	38,8	0,6	0,025	14
	-	24,6	-	37,2	0,6	23,2	24,5	38,8	0,6	0,025	14
	-	24,6	-	37,2	0,6	23,2	24,5	38,8	0,6	0,025	14
	27,2	-	-	37,2	0,6	23,2	27,1	38,8	0,6	0,025	14
	27,2	-	-	37,2	0,6	23,2	27,1	38,8	0,6	0,025	14
	28,8	-	-	40,6	1	25,6	-	41,4	1	0,025	13
	-	26	-	40,6	1	25,6	26	41,4	1	0,025	13
	-	26	-	40,6	1	25,6	26	41,4	1	0,025	13
	28,8	-	-	40,6	1	25,6	28,7	41,4	1	0,025	13
	28,2	-	39,6	-	1	25,6	-	41,4	1	0,025	12
	28,8	-	-	40,6	1	25,6	28,7	41,4	1	0,025	13
	-	26,9	-	44,8	1,1	27	27	45	1	0,03	12
	30,3	-	-	44,8	1,1	27	-	45	1	0,03	12
	-	26,9	-	44,8	1,1	27	27,3	45	1	0,03	12
	30,3	-	-	44,8	1,1	27	30,3	45	1	0,03	12
	30,3	-	42,6	-	1,1	27	-	45	1	0,03	12
	30,3	-	-	44,8	1,1	27	30,3	45	1	0,03	12
	37,1	-	54,8	-	1,1	29	-	63	1	0,035	11
22	32,2	-	-	44	1	27,6	32	44,4	1	0,025	14
	32,2	-	-	44	1	27,6	-	44,4	1	0,025	14
	32,9	-	45,3	-	1,1	29	-	47	1	0,03	12

1.1 Single row deep groove ball bearings

d 25 – 30 mm

1.1

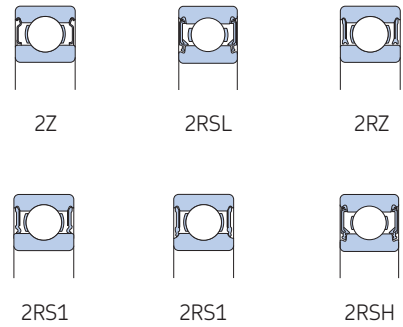
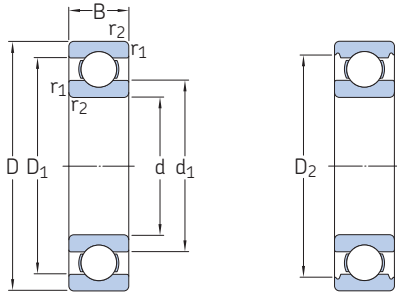

Principal dimensions			Basic load ratings		Fatigue load limit	Speed ratings		Mass	Designations	
d	D	B	C	C ₀	P _u	Reference speed	Limiting speed ¹⁾	kg	Bearing open or capped on both sides	capped on one side ¹⁾
mm			kN		kN	r/min		kg	–	
25	37	7	4,36	2,6	0,125	–	11 000	0,022	▶ 61805-2RS1	–
	37	7	4,36	2,6	0,125	38 000	19 000	0,022	▶ 61805-2RZ	–
	37	7	4,36	2,6	0,125	38 000	24 000	0,022	▶ 61805	–
42	42	9	7,02	4,3	0,193	–	10 000	0,045	▶ 61905-2RS1	–
	42	9	7,02	4,3	0,193	36 000	18 000	0,045	▶ 61905-2RZ	–
	42	9	7,02	4,3	0,193	36 000	22 000	0,045	▶ 61905	–
47	47	8	8,06	4,75	0,212	32 000	20 000	0,055	▶ 16005	–
	47	12	11,9	6,55	0,275	32 000	20 000	0,078	▶ 6005	–
	47	12	11,9	6,55	0,275	–	9 500	0,081	▶ 6005-2RSH	6005-RSH
47	47	12	11,9	6,55	0,275	32 000	16 000	0,08	▶ 6005-2RSL	6005-RSL
	47	12	11,9	6,55	0,275	32 000	16 000	0,083	▶ 6005-2Z	6005-Z
	47	16	11,2	6,55	0,275	–	9 500	0,11	63005-2RS1	–
52	52	15	14,8	7,8	0,335	28 000	18 000	0,13	▶ 6205	–
	52	15	14,8	7,8	0,335	–	8 500	0,13	▶ 6205-2RSH	6205-RSH
	52	15	14,8	7,8	0,335	28 000	14 000	0,13	▶ 6205-2RSL	6205-RSL
52	52	15	14,8	7,8	0,335	28 000	14 000	0,13	▶ 6205-2Z	6205-Z
	52	15	17,8	9,3	0,4	28 000	18 000	0,12	6205 ETN9	–
	52	18	14	7,8	0,335	–	8 500	0,13	62205-2RS1	–
62	62	17	23,4	11,6	0,49	24 000	16 000	0,23	▶ 6305	–
	62	17	23,4	11,6	0,49	–	7 500	0,24	▶ 6305-2RSH	6305-RSH
	62	17	23,4	11,6	0,49	24 000	13 000	0,23	6305-2RZ	6305-RZ
62	62	17	23,4	11,6	0,49	24 000	13 000	0,23	▶ 6305-2Z	6305-Z
	62	17	26	13,4	0,57	24 000	16 000	0,22	6305 ETN9	–
	62	24	22,5	11,6	0,49	–	7 500	0,32	62305-2RS1	–
80	80	21	35,8	19,3	0,815	20 000	13 000	0,54	6405	–
	68	18	25,1	13,7	0,585	22 000	14 000	0,3	63/28	–
28	58	16	16,8	9,5	0,405	26 000	16 000	0,17	62/28	–
	68	18	25,1	13,7	0,585	22 000	14 000	0,3	63/28	–
	68	18	25,1	13,7	0,585	22 000	14 000	0,3	63/28	–
30	42	7	4,49	2,9	0,146	–	9 500	0,025	▶ 61806-2RS1	–
	42	7	4,49	2,9	0,146	32 000	16 000	0,025	▶ 61806-2RZ	–
	42	7	4,49	2,9	0,146	32 000	20 000	0,025	▶ 61806	–
47	47	9	7,28	4,55	0,212	–	8 500	0,051	▶ 61906-2RS1	–
	47	9	7,28	4,55	0,212	30 000	15 000	0,051	▶ 61906-2RZ	–
	47	9	7,28	4,55	0,212	30 000	19 000	0,049	▶ 61906	–

SKF Explorer bearing

▶ Popular item

¹⁾ For bearings with only one shield or one non-contact seal (Z, RZ) the limiting speeds of the open bearings are valid.

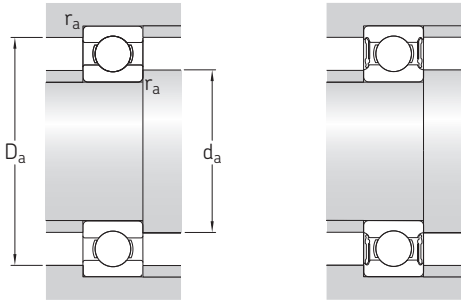

Dimensions						Abutment and fillet dimensions				Calculation factors	
d	d ₁ ≈	d ₂ ≈	D ₁ ≈	D ₂ ≈	r _{1,2} min.	d _a min.	d _a max.	D _a max.	r _a max.	k _r	f ₀
mm						mm				–	
25	–	27,4	–	34,2	0,6	27	27,3	35	0,3	0,015	14
	28,5	–	–	34,2	0,3	27	28,4	35	0,3	0,015	14
	28,5	–	33,2	–	0,6	27	–	35	0,3	0,015	14
	30,2	–	–	37,7	0,6	27	29	40	0,3	0,02	15
	30,2	–	–	37,7	0,6	27	29	40	0,3	0,02	15
	30,2	–	–	37,7	0,6	27	–	40	0,3	0,02	15
	33,3	–	–	42,4	0,3	27	–	45	0,3	0,02	15
	32	–	–	42,2	0,6	28,2	–	43,8	0,6	0,025	14
	–	29,4	–	42,2	0,6	28,2	29,5	43,8	0,6	0,025	14
	–	29,4	–	42,2	0,6	28,2	29,5	43,8	0,6	0,025	14
	32	–	–	42,2	0,6	28,2	31,9	43,8	0,6	0,025	14
	32	–	–	42,2	0,6	29,2	31,9	43,8	0,6	0,025	14
	34,3	–	–	46,3	1	30,6	–	46,4	1	0,025	14
	–	31,3	–	46,3	1	30,6	31,5	46,4	1	0,025	14
	–	31,3	–	46,3	1	30,6	31,5	46,4	1	0,025	14
	34,3	–	–	46,3	1	30,6	34,3	46,4	1	0,025	14
	33,1	–	–	46,3	1	30,6	–	46,4	1	0,025	13
	34,3	–	–	46,3	1	30,6	34,3	46,4	1	0,025	14
	36,6	–	–	52,7	1,1	32	–	55	1	0,03	12
	–	33	–	52,7	1,1	32	33	55	1	0,03	12
36,6	–	–	52,7	1,1	32	36,5	55	1	0,03	12	
36,6	–	–	52,7	1,1	32	36,5	55	1	0,03	12	
36,3	–	51,7	–	1,1	32	–	55	1	0,03	12	
36,6	–	–	52,7	1,1	32	36,5	55	1	0,03	12	
45,4	–	62,9	–	1,5	34	–	71	1,5	0,035	12	
28	37	–	–	51,5	1	33,6	–	52	1	0,025	14
	41,7	–	–	57,8	1,1	35	–	61	1	0,03	13
30	–	32,6	–	39,4	0,6	32	32,5	40	0,3	0,015	14
	33,7	–	–	39,4	0,6	32	33,6	40	0,3	0,015	14
	33,7	–	38,4	–	0,3	32	–	40	0,3	0,015	14
–	34,2	–	42,7	0,3	32	34	45	0,3	0,02	14	
35,2	–	–	42,7	0,3	32	35,1	45	0,3	0,02	14	
35,2	–	–	42,7	0,3	32	–	45	0,3	0,02	14	

1.1 Single row deep groove ball bearings

d 30 – 35 mm

1.1

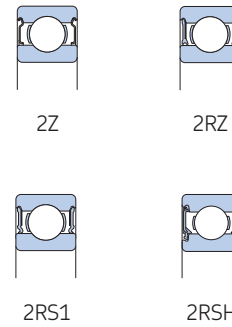
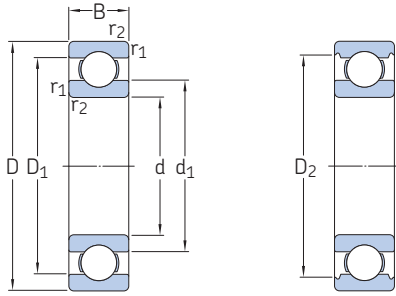

Principal dimensions			Basic load ratings		Fatigue load limit	Speed ratings		Mass	Designations	
d	D	B	C	C ₀	P _u	Reference speed	Limiting speed ¹⁾		Bearing open or capped on both sides	capped on one side ¹⁾
mm			kN		kN	r/min		kg	–	
30 cont.	55	9	11,9	7,35	0,31	28 000	17 000	0,089	▶ 16006	–
	55	13	13,8	8,3	0,355	28 000	17 000	0,12	▶ 6006	–
	55	13	13,8	8,3	0,355	–	8 000	0,12	▶ 6006-2RS1	6006-RS1
	55	13	13,8	8,3	0,355	28 000	14 000	0,12	▶ 6006-2RZ	6006-RZ
	55	13	13,8	8,3	0,355	28 000	14 000	0,12	▶ 6006-2Z	6006-Z
	55	19	13,3	8,3	0,355	–	8 000	0,17	63006-2RS1	–
	62	16	20,3	11,2	0,475	24 000	15 000	0,2	▶ 6206	–
	62	16	20,3	11,2	0,475	–	7 500	0,21	▶ 6206-2RSH	6206-RSH
	62	16	20,3	11,2	0,475	24 000	12 000	0,2	▶ 6206-2RZ	6206-RZ
	62	16	20,3	11,2	0,475	24 000	12 000	0,21	▶ 6206-2Z	6206-Z
	62	16	23,4	12,9	0,54	24 000	15 000	0,18	6206 ETN9	–
	62	20	19,5	11,2	0,475	–	7 500	0,25	62206-2RS1	–
	72	19	29,6	16	0,67	20 000	13 000	0,35	▶ 6306	–
	72	19	29,6	16	0,67	–	6 300	0,35	▶ 6306-2RSH	▶ 6306-RSH
	72	19	29,6	16	0,67	20 000	11 000	0,36	6306-2RZ	6306-RZ
	72	19	29,6	16	0,67	20 000	11 000	0,36	▶ 6306-2Z	6306-Z
	72	19	32,5	17,3	0,735	22 000	14 000	0,33	6306 ETN9	–
	72	27	28,1	16	0,67	–	6 300	0,5	62306-2RS1	–
	90	23	43,6	23,6	1	18 000	11 000	0,75	6406	–
	35	47	7	4,36	3,35	0,14	–	8 500	0,022	▶ 61807-2RS1
47		7	4,36	3,35	0,14	30 000	15 000	0,03	▶ 61807-2RZ	–
47		7	4,36	3,35	0,14	30 000	18 000	0,029	▶ 61807	–
55		10	10,8	7,8	0,325	–	7 500	0,08	▶ 61907-2RS1	–
55		10	10,8	7,8	0,325	26 000	13 000	0,08	▶ 61907-2RZ	–
55		10	10,8	7,8	0,325	26 000	16 000	0,08	▶ 61907	–
62		9	13	8,15	0,375	24 000	15 000	0,11	▶ 16007	–
62		14	16,8	10,2	0,44	24 000	15 000	0,15	▶ 6007	–
62		14	16,8	10,2	0,44	–	7 000	0,16	▶ 6007-2RS1	6007-RS1
62		14	16,8	10,2	0,44	24 000	12 000	0,16	6007-2RZ	6007-RZ
62		14	16,8	10,2	0,44	24 000	12 000	0,16	▶ 6007-2Z	6007-Z
62		20	15,9	10,2	0,44	–	7 000	0,22	63007-2RS1	–
72		17	27	15,3	0,655	20 000	13 000	0,29	▶ 6207	–
72		17	27	15,3	0,655	–	6 300	0,3	▶ 6207-2RSH	▶ 6207-RSH
72		17	27	15,3	0,655	20 000	10 000	0,3	▶ 6207-2Z	6207-Z

SKF Explorer bearing

▶ Popular item

¹⁾ For bearings with only one shield or one non-contact seal (Z, RZ) the limiting speeds of the open bearings are valid.

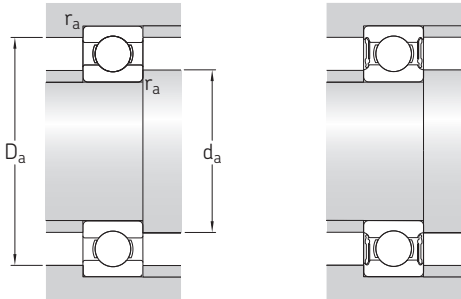

Dimensions						Abutment and fillet dimensions				Calculation factors	
d	d ₁ ≈	d ₂ ≈	D ₁ ≈	D ₂ ≈	r _{1,2} min.	d _a min.	d _a max.	D _a max.	r _a max.	k _r	f ₀
mm						mm				-	
30 cont.	37,7	-	47,3	-	0,3	32	-	53	0,3	0,02	15
	38,2	-	-	49	1	34,6	-	50	1	0,025	15
	38,2	-	-	49	1	34,6	38,1	50	1	0,025	15
	38,2	-	-	49	1	34,6	38,1	50	1	0,025	15
	38,2	-	-	49	1	34,6	38,1	50	1	0,025	15
	38,2	-	-	49	1	34,6	38,1	50	1	0,025	15
	40,3	-	-	54,1	1	35,6	-	56	1	0,025	14
	-	37,3	-	54,1	1	35,6	37,3	56	1	0,025	14
	40,3	-	-	54,1	1	35,6	40,3	56	1	0,025	14
	40,3	-	-	54,1	1	35,6	40,3	56	1	0,025	14
	39,5	-	52,9	-	1	35,6	-	56	1	0,025	13
	40,3	-	-	54,1	1	35,6	40,3	56	1	0,025	14
	44,6	-	-	61,9	1,1	37	-	65	1	0,03	13
	-	41,1	-	63,2	1,1	37	40,8	65	1	0,03	13
	44,6	-	-	61,9	1,1	37	44,5	65	1	0,03	13
44,6	-	-	61,9	1,1	37	44,5	65	1	0,03	13	
42,3	-	59,6	-	1,1	37	-	65	1	0,03	12	
44,6	-	-	61,9	1,1	37	44,5	65	1	0,03	13	
50,3	-	69,7	-	1,5	41	-	79	1,5	0,035	12	
35	38,2	-	-	44,4	0,3	37	38	45	0,3	0,015	14
	38,2	-	-	44,4	0,3	37	38	45	0,3	0,015	14
	38,2	-	42,8	-	0,3	37	-	45	0,3	0,015	14
	42,2	-	-	52,2	0,6	38,2	41,5	51	0,6	0,02	16
	42,2	-	-	52,2	0,6	38,2	41,5	51	0,6	0,02	16
	42,2	-	-	52,2	0,6	38,2	-	51	0,6	0,02	16
	44	-	53	-	0,3	37	-	60	0,3	0,02	14
	43,7	-	-	55,7	1	39,6	-	57	1	0,025	15
	43,7	-	-	55,7	1	39,6	43,7	57	1	0,025	15
	43,7	-	-	55,7	1	39,6	43,7	57	1	0,025	15
	43,7	-	-	55,7	1	39,6	43,7	57	1	0,025	15
	43,7	-	-	55,7	1	39,6	43,7	57	1	0,025	15
	46,9	-	-	62,7	1,1	42	-	65	1	0,025	14
	-	43,5	-	64,1	1,1	42	43,2	65	1	0,025	14
	46,9	-	-	62,7	1,1	42	46,8	65	1	0,025	14

1.1 Single row deep groove ball bearings

d 35 – 40 mm

1.1

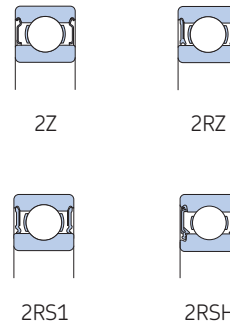
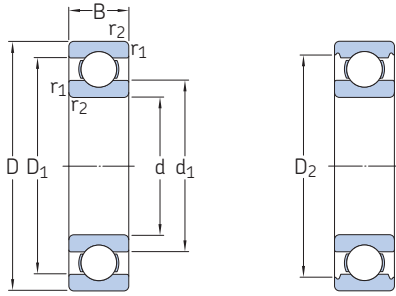

Principal dimensions			Basic load ratings		Fatigue load limit	Speed ratings		Mass	Designations		
d	D	B	C	C ₀	P _u	Reference speed	Limiting speed ¹⁾		Bearing open or capped on both sides	capped on one side ¹⁾	
mm			kN		kN	r/min		kg	–		
35 cont.	72	17	31,2	17,6	0,75	20 000	13 000	0,26	6207 ETN9	–	
	72	23	25,5	15,3	0,655	–	6 300	0,4	62207-2RS1	–	
	80	21	35,1	19	0,815	19 000	12 000	0,46	▶ 6307	–	
	80	21	35,1	19	0,815	19 000	17 000	0,54	6307 M	–	
	80	21	35,1	19	0,815	–	6 000	0,46	▶ 6307-2RSH	▶ 6307-RSH	
	80	21	35,1	19	0,815	19 000	9 500	0,48	▶ 6307-2Z	6307-Z	
	80	31	33,2	19	0,815	–	6 000	0,68	62307-2RS1	–	
	100	25	55,3	31	1,29	16 000	10 000	0,97	6407	–	
	40	52	7	4,49	3,75	0,16	26 000	13 000	0,034	▶ 61808-2RZ	–
		52	7	4,49	3,75	0,16	26 000	16 000	0,032	▶ 61808	–
62		12	13,8	10	0,425	–	6 700	0,12	▶ 61908-2RS1	–	
62		12	13,8	10	0,425	24 000	12 000	0,12	▶ 61908-2RZ	–	
62		12	13,8	10	0,425	24 000	14 000	0,12	▶ 61908	–	
68		9	13,8	10,2	0,44	22 000	14 000	0,13	▶ 16008	–	
68		15	17,8	11	0,49	22 000	14 000	0,19	▶ 6008	–	
68		15	17,8	11	0,49	–	6 300	0,2	▶ 6008-2RS1	6008-RS1	
68		15	17,8	11	0,49	22 000	11 000	0,2	6008-2RZ	6008-RZ	
68		15	17,8	11	0,49	22 000	11 000	0,2	▶ 6008-2Z	6008-Z	
68		21	16,8	11	0,49	–	6 300	0,27	63008-2RS1	–	
80		18	32,5	19	0,8	18 000	11 000	0,37	▶ 6208	–	
80		18	32,5	19	0,8	–	5 600	0,37	▶ 6208-2RSH	▶ 6208-RSH	
80		18	32,5	19	0,8	18 000	9 000	0,38	6208-2RZ	6208-RZ	
80		18	32,5	19	0,8	18 000	9 000	0,38	▶ 6208-2Z	6208-Z	
80		18	35,8	20,8	0,88	18 000	11 000	0,34	6208 ETN9	–	
80		23	30,7	19	0,8	–	5 600	0,47	62208-2RS1	–	
90		23	42,3	24	1,02	17 000	11 000	0,63	▶ 6308	–	
90		23	42,3	24	1,02	–	5 000	0,64	▶ 6308-2RSH	▶ 6308-RSH	
90		23	42,3	24	1,02	17 000	8 500	0,65	▶ 6308-2RZ	6308-RZ	
90	23	42,3	24	1,02	17 000	8 500	0,65	▶ 6308-2Z	6308-Z		
90	33	41	24	1,02	–	5 000	0,92	62308-2RS1	–		
110	27	63,7	36,5	1,53	14 000	9 000	1,25	6408	–		

SKF Explorer bearing

▶ Popular item

¹⁾ For bearings with only one shield or one non-contact seal (Z, RZ) the limiting speeds of the open bearings are valid.

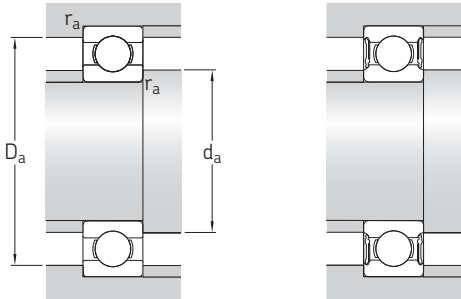

Dimensions						Abutment and fillet dimensions				Calculation factors	
d	d ₁ ≈	d ₂ ≈	D ₁ ≈	D ₂ ≈	r _{1,2} min.	d _a min.	d _a max.	D _a max.	r _a max.	k _r	f ₀
mm						mm				–	
35 cont.	46,1	–	61,7	–	1,1	42	–	65	1	0,025	13
	46,9	–	–	62,7	1,1	42	46,8	65	1	0,025	14
	49,5	–	–	69,2	1,5	44	–	71	1,5	0,03	13
	49,5	–	–	69,2	1,5	44	–	71	1,5	0,03	13
	–	45,9	–	70,2	1,5	44	45,6	71	1,5	0,03	13
	49,5	–	–	69,2	1,5	44	49,5	71	1,5	0,03	13
	49,5	–	–	69,2	1,5	44	49,5	71	1,5	0,03	13
	57,4	–	79,6	–	1,5	46	–	89	1,5	0,035	12
40	43,2	–	–	49,3	0,3	42	43	50	0,3	0,015	15
	43,2	–	48,1	–	0,3	42	–	50	0,3	0,015	15
	46,9	–	–	57,3	0,6	43,2	46,8	58	0,6	0,02	16
	46,9	–	–	57,3	0,6	43,2	46,8	58	0,6	0,02	16
	46,9	–	55,6	–	0,6	43,2	–	58	0,6	0,02	16
	49,4	–	58,6	–	0,3	42	–	66	0,3	0,02	16
	49,2	–	–	61,1	1	44,6	–	63	1	0,025	15
	49,2	–	–	61,1	1	44,6	49,2	63	1	0,025	15
	49,2	–	–	61,1	1	44,6	49,2	63	1	0,025	15
	49,2	–	–	61,1	1	44,6	49,2	63	1	0,025	15
	49,2	–	–	61,1	1	44,6	49,2	63	1	0,025	15
	52,6	–	–	69,8	1,1	47	–	73	1	0,025	14
	–	49,1	–	71,5	1,1	47	48,8	73	1	0,025	14
	52,6	–	–	69,8	1,1	47	52	73	1	0,025	14
	52,6	–	–	69,8	1,1	47	52	73	1	0,025	14
	52	–	68,8	–	1,1	47	–	73	1	0,025	13
	52,6	–	–	69,8	1,1	47	52	73	1	0,025	14
	56,1	–	–	77,7	1,5	49	–	81	1,5	0,03	13
	–	52,3	–	78,6	1,5	49	52	81	1,5	0,03	13
	56,1	–	–	77,7	1,5	49	56	81	1,5	0,03	13
56,1	–	–	77,7	1,5	49	56	81	1,5	0,03	13	
56,1	–	–	77,7	1,5	49	56	81	1,5	0,03	13	
62,8	–	87	–	2	53	–	97	2	0,035	12	

1.1 Single row deep groove ball bearings

d 45 – 50 mm

1.1

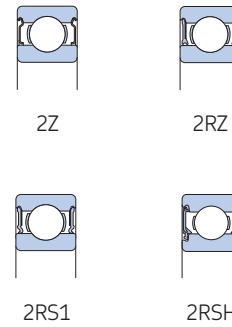
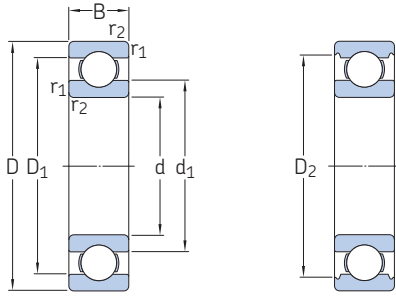

Principal dimensions			Basic load ratings		Fatigue load limit	Speed ratings		Mass	Designations	
d	D	B	dynamic	static		Reference speed	Limiting speed ¹⁾		Bearing open or capped on both sides	capped on one side ¹⁾
mm			kN		kN	r/min	kg	–		
45	58	7	6,63	6,1	0,26	–	6 700	0,04	▶ 61809-2RS1	–
	58	7	6,63	6,1	0,26	22 000	11 000	0,04	▶ 61809-2RZ	–
	58	7	6,63	6,1	0,26	22 000	14 000	0,04	▶ 61809	–
	68	12	14	10,8	0,465	–	6 000	0,14	▶ 61909-2RS1	–
	68	12	14	10,8	0,465	20 000	10 000	0,14	▶ 61909-2RZ	–
	68	12	14	10,8	0,465	20 000	13 000	0,14	▶ 61909	–
	75	10	16,5	10,8	0,52	20 000	12 000	0,17	▶ 16009	–
	75	16	22,1	14,6	0,64	20 000	12 000	0,24	▶ 6009	–
	75	16	22,1	14,6	0,64	–	5 600	0,25	▶ 6009-2RS1	6009-RS1
	75	16	22,1	14,6	0,64	20 000	10 000	0,25	▶ 6009-2Z	6009-Z
	75	23	20,8	14,6	0,64	–	5 600	0,36	63009-2RS1	–
	85	19	35,1	21,6	0,915	17 000	11 000	0,42	▶ 6209	–
	85	19	35,1	21,6	0,915	–	5 000	0,42	▶ 6209-2RSH	▶ 6209-RSH
	85	19	35,1	21,6	0,92	17 000	8 500	0,43	▶ 6209-2Z	6209-Z
	85	23	33,2	21,6	0,915	–	5 000	0,51	62209-2RS1	–
100	25	55,3	31,5	1,34	15 000	9 500	0,84	▶ 6309	–	
100	25	55,3	31,5	1,34	15 000	14 000	0,85	6309 M	–	
100	25	55,3	31,5	1,34	–	4 500	0,85	▶ 6309-2RSH	▶ 6309-RSH	
100	25	55,3	31,5	1,34	15 000	7 500	0,87	▶ 6309-2Z	6309-Z	
100	36	52,7	31,5	1,34	–	4 500	1,2	62309-2RS1	–	
120	29	76,1	45	1,9	13 000	8 500	1,55	6409	–	
50	65	7	6,76	6,8	0,285	–	6 000	0,052	▶ 61810-2RS1	–
	65	7	6,76	6,8	0,285	20 000	10 000	0,052	▶ 61810-2RZ	–
	65	7	6,76	6,8	0,285	20 000	13 000	0,052	▶ 61810	–
	72	12	14,6	11,8	0,5	–	5 600	0,14	▶ 61910-2RS1	–
	72	12	14,6	11,8	0,5	19 000	9 500	0,14	▶ 61910-2RZ	–
	72	12	14,6	11,8	0,5	19 000	12 000	0,14	▶ 61910	–
	80	10	16,8	11,4	0,56	18 000	11 000	0,18	▶ 16010	–
	80	16	22,9	15,6	0,71	18 000	11 000	0,26	▶ 6010	–
	80	16	22,9	15,6	0,71	–	5 000	0,27	▶ 6010-2RS1	6010-RS1
	80	16	22,9	15,6	0,71	18 000	9 000	0,27	6010-2RZ	6010-RZ
	80	16	22,9	15,6	0,71	18 000	9 000	0,27	▶ 6010-2Z	6010-Z
	80	23	21,6	15,6	0,71	–	5 000	0,38	63010-2RS1	–
	90	20	37,1	23,2	0,98	15 000	10 000	0,46	▶ 6210	–
	90	20	37,1	23,2	0,98	15 000	14 000	0,52	6210 M	–
	90	20	37,1	23,2	0,98	–	4 800	0,46	▶ 6210-2RSH	▶ 6210-RSH

SKF Explorer bearing

▶ Popular item

¹⁾ For bearings with only one shield or one non-contact seal (Z, RZ) the limiting speeds of the open bearings are valid.

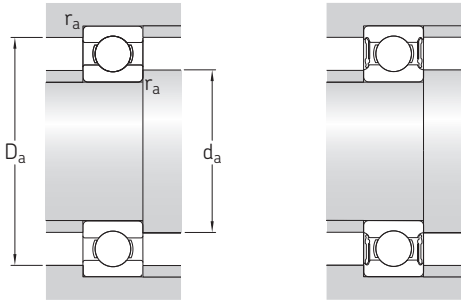

Dimensions						Abutment and fillet dimensions				Calculation factors	
d	d ₁ ≈	d ₂ ≈	D ₁ ≈	D ₂ ≈	r _{1,2} min.	d _a min.	d _a max.	D _a max.	r _a max.	k _r	f ₀
mm						mm				–	
45	48,2	–	–	55,4	0,3	47	49	56	0,3	0,015	17
	48,2	–	–	55,4	0,3	47	49	56	0,3	0,015	17
	48,2	–	54	–	0,3	47	–	56	0,3	0,015	17
	52,4	–	–	62,8	0,6	48,2	52	64	0,6	0,02	16
	52,4	–	–	62,8	0,6	48,2	52	64	0,6	0,02	16
	52,4	–	61,2	–	0,6	48,2	–	64	0,6	0,02	16
	55	–	65	–	0,6	48,2	–	71	0,6	0,02	14
	54,7	–	–	67,8	1	51	–	69	1	0,025	15
	54,7	–	–	67,8	1	51	54	69	1	0,025	15
	54,7	–	–	67,8	1	51	54	69	1	0,025	15
	54,7	–	–	67,8	1	51	54	69	1	0,025	15
	57,6	–	–	75,2	1,1	52	–	78	1	0,025	14
	–	54,1	–	76,5	1,1	52	53	78	1	0,025	14
	57,6	–	–	75,2	1,1	52	57	78	1	0,025	14
	57,6	–	–	75,2	1,1	52	57	78	1	0,025	14
50	62,1	–	–	86,7	1,5	54	–	91	1,5	0,03	13
	62,1	–	–	86,7	1,5	54	–	91	1,5	0,03	13
	–	58,2	–	87,5	1,5	54	57	91	1,5	0,03	13
	62,1	–	–	86,7	1,5	54	62	91	1,5	0,03	13
	62,1	–	–	86,7	1,5	54	62	91	1,5	0,03	13
	68,9	–	95,9	–	2	58	–	107	2	0,035	12
	54,6	–	–	61,8	0,3	52	55	63	0,3	0,015	17
	54,6	–	–	61,8	0,3	52	55	63	0,3	0,015	17
	54,6	–	60,3	–	0,3	52	–	63	0,3	0,015	17
	56,8	–	–	67,3	0,6	54	56	68	0,6	0,02	16
	56,8	–	–	67,3	0,6	54	56	68	0,6	0,02	16
	56,8	–	65,6	–	0,6	54	–	68	0,6	0,02	16
	60	–	70	–	0,6	54	–	76	0,6	0,02	14
	59,7	–	–	72,8	1	55	–	75	1	0,025	15
	59,7	–	–	72,8	1	55	59	75	1	0,025	15
59,7	–	–	72,8	1	55	59	75	1	0,025	15	
59,7	–	–	72,8	1	55	59	75	1	0,025	15	
59,7	–	–	72,8	1	55	59	75	1	0,025	15	
62,5	–	–	81,7	1,1	57	–	83	1	0,025	14	
62,5	–	–	81,7	1,1	57	–	83	1	0,025	14	
–	58,8	–	82,2	1,1	57	58	83	1	0,025	14	

1.1 Single row deep groove ball bearings

d 50 – 55 mm

1.1

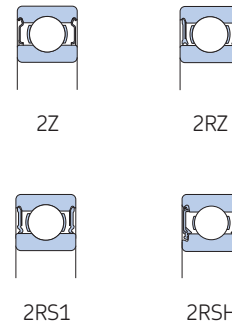
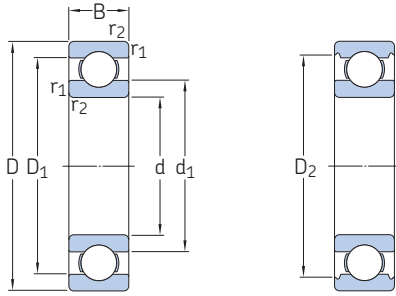

Principal dimensions			Basic load ratings		Fatigue load limit	Speed ratings		Mass	Designations	
d	D	B	C	C ₀		Reference speed	Limiting speed ¹⁾		Bearing open or capped on both sides	capped on one side ¹⁾
mm			kN		kN	r/min	kg	–		
50 cont.	90	20	37,1	23,2	0,98	15 000	8 000	0,47	▶ 6210-2Z	6210-Z
	90	20	37,1	23,2	0,98	15 000	8 000	0,48	▶ 6210-2RZ	6210-RZ
	90	23	35,1	23,2	0,98	–	4 800	0,54	▶ 62210-2RS1	–
	110	27	65	38	1,6	13 000	8 500	1,3	▶ 6310 M	–
	110	27	65	38	1,6	–	4 300	1,1	▶ 6310-2RSH	▶ 6310-RSH
	110	27	65	38	1,6	13 000	8 500	1,1	▶ 6310	–
	110	27	65	38	1,6	13 000	6 700	1,1	▶ 6310-2Z	6310-Z
	110	40	61,8	38	1,6	–	4 300	1,6	▶ 62310-2RS1	–
	130	31	87,1	52	2,2	12 000	7 500	1,95	▶ 6410	–
55	72	9	9,04	8,8	0,375	–	5 300	0,083	▶ 61811-2RS1	–
	72	9	9,04	8,8	0,375	19 000	9 500	0,083	▶ 61811-2RZ	–
	72	9	9,04	8,8	0,375	19 000	12 000	0,083	▶ 61811	–
	80	13	16,5	14	0,6	–	5 000	0,19	▶ 61911-2RS1	–
	80	13	16,5	14	0,6	17 000	8 500	0,19	▶ 61911-2RZ	–
	80	13	16,5	14	0,6	17 000	11 000	0,19	▶ 61911	–
	90	11	20,3	14	0,695	16 000	10 000	0,26	▶ 16011	–
	90	18	29,6	21,2	0,9	16 000	14 000	0,44	▶ 6011 M	–
	90	18	29,6	21,2	0,9	16 000	10 000	0,38	▶ 6011	–
	90	18	29,6	21,2	0,9	–	4 500	0,4	▶ 6011-2RS1	6011-RS1
	90	18	29,6	21,2	0,9	16 000	8 000	0,4	▶ 6011-2Z	6011-Z
	100	21	46,2	29	1,25	14 000	9 000	0,61	▶ 6211	–
	100	21	46,2	29	1,25	14 000	13 000	0,72	▶ 6211 M	–
	100	21	46,2	29	1,25	–	4 300	0,62	▶ 6211-2RSH	▶ 6211-RSH
	100	21	46,2	29	1,25	14 000	7 000	0,64	▶ 6211-2Z	6211-Z
	100	25	43,6	29	1,25	–	4 300	0,75	▶ 62211-2RS1	–
	120	29	74,1	45	1,9	12 000	8 000	1,35	▶ 6311	–
	120	29	74,1	45	1,9	12 000	11 000	1,65	▶ 6311 M	–
	120	29	74,1	45	1,9	–	3 800	1,4	▶ 6311-2RSH	▶ 6311-RSH
	120	29	74,1	45	1,9	12 000	6 300	1,4	▶ 6311-2Z	6311-Z
	120	43	71,5	45	1,9	–	3 800	2,05	▶ 62311-2RS1	–
	140	33	99,5	62	2,6	11 000	7 000	2,35	▶ 6411	–

SKF Explorer bearing

▶ Popular item

¹⁾ For bearings with only one shield or one non-contact seal (Z, RZ) the limiting speeds of the open bearings are valid.

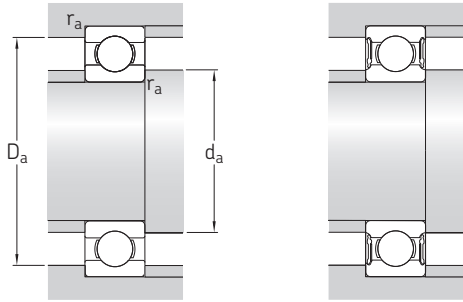

Dimensions						Abutment and fillet dimensions				Calculation factors	
d	d ₁ ≈	d ₂ ≈	D ₁ ≈	D ₂ ≈	r _{1,2} min.	d _a min.	d _a max.	D _a max.	r _a max.	k _r	f ₀
mm						mm				–	
50 cont.	62,5	–	–	81,7	1,1	57	62	83	1	0,025	14
	62,5	–	–	81,7	1,1	57	62	83	1	0,025	14
	62,5	–	–	81,7	1,1	57	62	83	1	0,025	14
	68,7	–	–	95,2	2	61	–	99	2	0,03	13
	–	64,7	–	95,9	2	61	64	99	2	0,03	13
	68,7	–	–	95,2	2	61	–	99	2	0,03	13
	68,7	–	–	95,2	2	61	68	99	2	0,03	13
	68,7	–	–	95,2	2	61	68	99	2	0,03	13
	75,4	–	105	–	2,1	64	–	116	2	0,035	12
	55	60,3	–	–	68,6	0,3	57	60	70	0,3	0,015
60,3		–	–	68,6	0,3	57	60	70	0,3	0,015	17
60,3		–	67	–	0,3	57	–	70	0,3	0,015	17
63		–	–	74,2	1	60	63	75	1	0,02	16
63		–	–	74,2	1	60	63	75	1	0,02	16
63		–	72,3	–	1	60	–	75	1	0,02	16
67		–	78,1	–	0,6	59	–	86	0,6	0,02	14
66,3		–	–	81,5	1,1	61	–	84	1	0,025	15
66,3		–	–	81,5	1,1	61	–	84	1	0,025	15
66,3		–	–	81,5	1,1	61	66	84	1	0,025	15
66,3		–	–	81,5	1,1	61	66	84	1	0,025	15
69		–	–	89,4	1,5	64	–	91	1,5	0,025	14
69		–	–	89,4	1,5	64	–	91	1,5	0,025	14
–		65,2	–	90,5	1,5	64	64	91	1,5	0,025	14
69		–	–	89,4	1,5	64	69	91	1,5	0,025	14
69		–	–	89,4	1,5	64	69	91	1,5	0,025	14
75,3		–	–	104	2	66	–	109	2	0,03	13
75,3		–	–	104	2	66	–	109	2	0,03	13
–		71,1	–	105	2	66	70	109	2	0,03	13
75,3		–	–	104	2	66	75	109	2	0,03	13
75,3		–	–	104	2	66	75	109	2	0,03	13
81,5		–	114	–	2,1	69	–	126	2	0,035	12

1.1 Single row deep groove ball bearings

d 60 – 65 mm

1.1

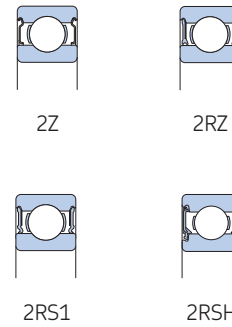
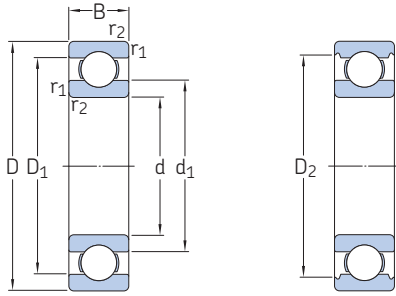

Principal dimensions			Basic load ratings		Fatigue load limit	Speed ratings		Mass	Designations	
d	D	B	C	C ₀		Reference speed	Limiting speed ¹⁾		Bearing open or capped on both sides	capped on one side ¹⁾
mm			kN		kN	r/min		kg	–	
60	78	10	11,9	11,4	0,49	–	4 800	0,11	▶ 61812-2RS1	–
	78	10	11,9	11,4	0,49	17 000	8 500	0,11	▶ 61812-2RZ	–
	78	10	11,9	11,4	0,49	17 000	11 000	0,11	▶ 61812	–
	85	13	16,5	12	0,6	–	4 500	0,21	▶ 61912-2RS1	–
	85	13	16,5	12	0,6	16 000	10 000	0,2	▶ 61912	–
	85	13	16,5	14,3	0,6	16 000	8 000	0,2	▶ 61912-2RZ	–
	95	11	20,8	15	0,735	15 000	9 500	0,29	▶ 16012	–
	95	18	30,7	23,2	0,98	15 000	9 500	0,41	▶ 6012	–
	95	18	30,7	23,2	0,98	–	4 300	0,43	▶ 6012-2RS1	6012-RS1
	95	18	30,7	23,2	0,98	15 000	7 500	0,43	▶ 6012-2RZ	6012-RZ
	95	18	30,7	23,2	0,98	15 000	7 500	0,43	▶ 6012-2Z	6012-Z
	110	22	55,3	36	1,53	13 000	8 000	0,78	▶ 6212	–
	110	22	55,3	36	1,53	13 000	8 000	0,93	▶ 6212 M	–
	110	22	55,3	36	1,53	–	4 000	0,79	▶ 6212-2RSH	▶ 6212-RSH
	110	22	55,3	36	1,53	13 000	6 300	0,81	▶ 6212-2Z	6212-Z
	110	28	52,7	36	1,53	–	4 000	1	▶ 62212-2RS1	–
	130	31	85,2	52	2,2	11 000	7 000	2,1	▶ 6312 M	–
	130	31	85,2	52	2,2	–	3 400	1,75	▶ 6312-2RSH	▶ 6312-RSH
130	31	85,2	52	2,2	11 000	5 600	1,8	▶ 6312-2Z	6312-Z	
130	31	85,2	52	2,2	11 000	7 000	1,7	▶ 6312	–	
130	46	81,9	52	2,2	–	3 400	2,55	▶ 62312-2RS1	–	
150	35	108	69,5	2,9	10 000	6 300	2,85	▶ 6412	–	
65	85	10	12,4	12,7	0,54	–	4 500	0,13	▶ 61813-2RS1	–
	85	10	12,4	12,7	0,54	16 000	8 000	0,13	▶ 61813-2RZ	–
	85	10	12,4	12,7	0,54	16 000	10 000	0,13	▶ 61813	–
	90	13	17,4	16	0,68	–	4 300	0,22	▶ 61913-2RS1	–
	90	13	17,4	16	0,68	15 000	7 500	0,22	▶ 61913-2RZ	–
	90	13	17,4	16	0,68	15 000	9 500	0,22	▶ 61913	–
	100	11	22,5	19,6	0,83	14 000	9 000	0,3	▶ 16013	–
	100	18	31,9	25	1,06	14 000	9 000	0,44	▶ 6013	–
	100	18	31,9	25	1,06	14 000	12 000	0,44	▶ 6013 M	–
	100	18	31,9	25	1,06	–	4 000	0,45	▶ 6013-2RS1	6013-RS1
	100	18	31,9	25	1,06	14 000	7 000	0,46	▶ 6013-2Z	6013-Z
	120	23	58,5	40,5	1,73	12 000	10 000	1,2	▶ 6213 M	–

SKF Explorer bearing

▶ Popular item

¹⁾ For bearings with only one shield or one non-contact seal (Z, RZ) the limiting speeds of the open bearings are valid.

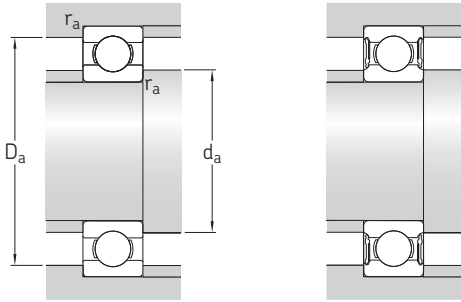

Dimensions						Abutment and fillet dimensions				Calculation factors	
d	d ₁ ≈	d ₂ ≈	D ₁ ≈	D ₂ ≈	r _{1,2} min.	d _a min.	d _a max.	D _a max.	r _a max.	k _r	f ₀
mm						mm				–	
60	65,4	–	–	74,5	0,3	62	65	76	0,3	0,015	17
	65,4	–	–	74,5	0,3	62	65	76	0,3	0,015	17
	65,4	–	72,9	–	0,3	62	–	76	0,3	0,015	17
	68,3	–	–	78,7	1	65	68	80	1	0,02	14
	68,3	–	–	78,7	1	65	–	80	1	0,02	14
	68,3	–	–	78,7	1	65	68	80	1	0,02	16
	72	–	83	–	0,6	64	–	91	0,6	0,02	14
	71,3	–	–	86,5	1,1	66	–	89	1	0,025	16
	71,3	–	–	86,5	1,1	66	71	89	1	0,025	16
	71,3	–	–	86,5	1,1	66	71	89	1	0,025	16
	71,3	–	–	86,5	1,1	66	71	89	1	0,025	16
	75,5	–	–	98	1,5	69	–	101	1,5	0,025	14
	75,5	–	–	98	1,5	69	–	101	1,5	0,025	14
	–	71,5	–	99,5	1,5	69	71	101	1,5	0,025	14
	75,5	–	–	98	1,5	69	75	101	1,5	0,025	14
	75,5	–	–	98	1,5	69	75	101	1,5	0,025	14
	81,8	–	–	113	2,1	72	–	118	2	0,03	13
	–	77,5	–	113	2,1	72	77	118	2	0,03	13
	81,8	–	–	113	2,1	72	81	118	2	0,03	13
	81,8	–	–	113	2,1	72	–	118	2	0,03	13
81,8	–	–	113	2,1	72	81	118	2	0,03	13	
88,1	–	122	–	2,1	74	–	136	2	0,035	12	
65	71,4	–	–	80,5	0,6	69	71	81	0,6	0,015	17
	71,4	–	–	80,5	0,6	69	71	81	0,6	0,015	17
	71,4	–	78,9	–	0,6	69	–	81	0,6	0,015	17
	73	–	–	84,2	1	70	73	85	1	0,02	17
	73	–	–	84,2	1	70	73	85	1	0,02	17
	73	–	82,3	–	1	70	–	85	1	0,02	17
	76,5	–	88,4	–	0,6	69	–	96	0,6	0,02	16
	76,3	–	–	91,5	1,1	71	–	94	1	0,025	16
	76,3	–	–	91,5	1,1	71	–	94	1	0,025	16
	76,3	–	–	91,5	1,1	71	76	94	1	0,025	16
	76,3	–	–	91,5	1,1	71	76	94	1	0,025	16
	83,3	–	–	106	1,5	74	–	111	1,5	0,025	15

1.1 Single row deep groove ball bearings

d 65 – 70 mm

1.1

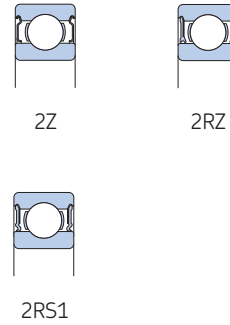
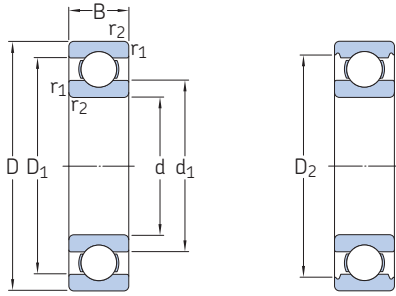

Principal dimensions			Basic load ratings		Fatigue load limit	Speed ratings		Mass	Designations	
d	D	B	dynamic	static		Reference speed	Limiting speed ¹⁾		Bearing open or capped on both sides	capped on one side ¹⁾
mm			kN		kN	r/min	kg	–		
65 cont.	120	23	58,5	40,5	1,73	12 000	7 500	1	▶ 6213	–
	120	23	58,5	40,5	1,73	–	3 600	1,05	▶ 6213-2RS1	6213-RS1
	120	23	58,5	40,5	1,73	12 000	6 000	1,05	▶ 6213-2Z	6213-Z
	120	31	55,9	40,5	1,73	–	3 600	1,4	62213-2RS1	–
	140	33	97,5	60	2,5	10 000	6 700	2,55	6313 M	–
	140	33	97,5	60	2,5	10 000	6 700	2,1	▶ 6313	–
	140	33	97,5	60	2,5	–	3 200	2,15	▶ 6313-2RS1	6313-RS1
	140	33	97,5	60	2,5	10 000	5 300	2,15	▶ 6313-2Z	6313-Z
	140	48	92,3	60	2,5	–	3 200	3	62313-2RS1	–
	160	37	119	78	3,15	9 500	6 000	3,35	6413	–
70	90	10	12,4	13,2	0,56	–	4 300	0,14	▶ 61814-2RS1	–
	90	10	12,4	13,2	0,56	15 000	7 500	0,14	▶ 61814-2RZ	–
	90	10	12,4	13,2	0,56	15 000	9 000	0,14	▶ 61814	–
	100	16	23,8	18,3	0,9	14 000	8 500	0,34	▶ 61914	–
	100	16	23,8	21,2	0,9	–	4 000	0,35	61914-2RS1	–
	100	16	23,8	21,2	0,9	14 000	7 000	0,35	61914-2RZ	–
	110	13	29,1	25	1,06	13 000	8 000	0,44	▶ 16014	–
	110	20	39,7	31	1,32	13 000	11 000	0,7	6014 M	–
	110	20	39,7	31	1,32	13 000	8 000	0,61	▶ 6014	–
	110	20	39,7	31	1,32	–	3 600	0,63	▶ 6014-2RS1	6014-RS1
	110	20	39,7	31	1,32	13 000	6 300	0,64	▶ 6014-2Z	6014-Z
	125	24	60,5	45	1,9	11 000	10 000	1,3	6214 M	–
	125	24	63,7	45	1,9	11 000	7 000	1,1	▶ 6214	–
	125	24	63,7	45	1,9	–	3 400	1,1	▶ 6214-2RS1	6214-RS1
	125	24	63,7	45	1,9	11 000	5 600	1,15	▶ 6214-2Z	6214-Z
	125	31	60,5	45	1,9	–	3 400	1,4	62214-2RS1	–
	150	35	111	68	2,75	9 500	6 300	2,55	▶ 6314	–
	150	35	111	68	2,75	9 500	6 300	3,1	6314 M	–
	150	35	111	68	2,75	–	3 000	2,6	▶ 6314-2RS1	6314-RS1
	150	35	111	68	2,75	9 500	5 000	2,65	▶ 6314-2Z	6314-Z
150	51	104	68	2,75	–	3 000	3,75	62314-2RS1	–	
180	42	143	104	3,9	8 500	5 300	4,95	6414	–	

SKF Explorer bearing

▶ Popular item

¹⁾ For bearings with only one shield or one non-contact seal (Z, RZ) the limiting speeds of the open bearings are valid.

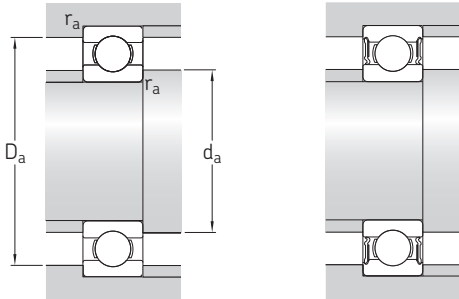

Dimensions						Abutment and fillet dimensions				Calculation factors		
d	d ₁ ≈	d ₂ ≈	D ₁ ≈	D ₂ ≈	r _{1,2} min.	d _a min.	d _a max.	D _a max.	r _a max.	k _r	f ₀	
mm						mm				–		
65 cont.	83,3	–	–	106	1,5	74	–	111	1,5	0,025	15	
	83,3	–	–	106	1,5	74	83	111	1,5	0,025	15	
	83,3	–	–	106	1,5	74	83	111	1,5	0,025	15	
	83,3	–	–	106	1,5	74	83	111	1,5	0,025	15	
	88,3	–	–	122	2,1	77	–	128	2	0,03	13	
	88,3	–	–	122	2,1	77	–	128	2	0,03	13	
	88,3	–	–	122	2,1	77	88	128	2	0,03	13	
	88,3	–	–	122	2,1	77	88	128	2	0,03	13	
	88,3	–	–	122	2,1	77	88	128	2	0,03	13	
	94	–	131	–	–	2,1	79	–	146	2	0,035	12
	70	76,4	–	–	85,5	0,6	74	76	86	0,6	0,015	17
		76,4	–	–	85,5	0,6	74	76	86	0,6	0,015	17
76,4		–	83,9	–	0,6	74	–	86	0,6	0,015	17	
79,8		–	–	92,9	1	75	–	95	1	0,02	14	
79,8		–	–	92,9	1	75	79	95	1	0,02	16	
79,8		–	–	92,9	1	75	79	95	1	0,02	16	
83,3		–	96,8	–	0,6	74	–	106	0,6	0,02	16	
82,8		–	–	99,9	1,1	76	–	104	1	0,025	16	
82,8		–	–	99,9	1,1	76	–	104	1	0,025	16	
82,8		–	–	99,9	1,1	76	82	104	1	0,025	16	
82,8		–	–	99,9	1,1	76	82	104	1	0,025	16	
87		–	–	111	1,5	79	–	116	1,5	0,025	15	
87		–	–	111	1,5	79	–	116	1,5	0,025	15	
87		–	–	111	1,5	79	87	116	1,5	0,025	15	
87		–	–	111	1,5	79	87	116	1,5	0,025	15	
87		–	–	111	1,5	79	87	116	1,5	0,025	15	
94,9		–	–	130	2,1	82	–	138	2	0,03	13	
94,9		–	–	130	2,1	82	–	138	2	0,03	13	
94,9		–	–	130	2,1	82	94	138	2	0,03	13	
94,9		–	–	130	2,1	82	94	138	2	0,03	13	
94,9		–	–	130	2,1	82	94	138	2	0,03	13	
103		–	146	–	–	3	86	–	164	2,5	0,035	12

1.1 Single row deep groove ball bearings

d 75 – 80 mm

1.1

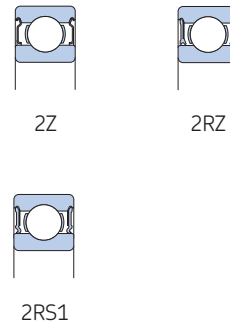
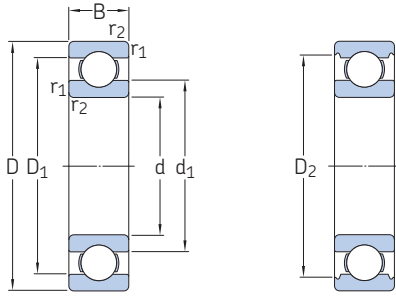

Principal dimensions			Basic load ratings		Fatigue load limit	Speed ratings		Mass	Designations	
d	D	B	dynamic	static		Reference speed	Limiting speed ¹⁾		Bearing open or capped on both sides	capped on one side ¹⁾
mm			kN		kN	r/min	kg	–		
75	95	10	12,5	10,8	0,585	–	4 000	0,15	▶ 61815-2RS1	–
	95	10	12,5	10,8	0,585	14 000	7 000	0,15	▶ 61815-2RZ	–
	95	10	12,5	10,8	0,585	14 000	8 500	0,15	▶ 61815	–
	105	16	24,2	19,3	0,965	13 000	8 000	0,36	▶ 61915	–
	105	16	24,2	22,4	0,965	–	3 600	0,37	61915-2RS1	–
	105	16	24,2	22,4	0,965	13 000	6 300	0,37	61915-2RZ	–
	115	13	30,2	27	1,14	12 000	7 500	0,46	▶ 16015	–
	115	20	41,6	33,5	1,43	12 000	10 000	0,74	6015 M	–
	115	20	41,6	33,5	1,43	12 000	7 500	0,65	▶ 6015	–
	115	20	41,6	33,5	1,43	–	3 400	0,67	▶ 6015-2RS1	6015-RS1
	115	20	41,6	33,5	1,43	12 000	6 000	0,67	6015-2RZ	6015-RZ
	115	20	41,6	33,5	1,43	12 000	6 000	0,68	▶ 6015-2Z	6015-Z
	130	25	68,9	49	2,04	10 000	9 500	1,4	6215 M	–
	130	25	68,9	49	2,04	10 000	6 700	1,2	▶ 6215	–
130	25	68,9	49	2,04	–	3 200	1,2	▶ 6215-2RS1	6215-RS1	
130	25	68,9	49	2,04	10 000	5 300	1,25	▶ 6215-2Z	6215-Z	
160	37	119	76,5	3	9 000	5 600	3,05	▶ 6315	–	
160	37	119	76,5	3	9 000	5 600	3,7	6315 M	–	
160	37	119	76,5	3	–	2 800	3,15	▶ 6315-2RS1	6315-RS1	
160	37	119	76,5	3	9 000	4 500	3,15	▶ 6315-2Z	6315-Z	
190	45	153	114	4,15	8 000	5 000	5,8	6415	–	
80	100	10	12,7	11,2	0,61	–	3 600	0,16	▶ 61816-2RS1	–
	100	10	12,7	11,2	0,61	13 000	8 000	0,15	▶ 61816	–
	110	16	25,1	20,4	1,02	–	3 400	0,4	▶ 61916-2RS1	–
	110	16	25,1	20,4	1,02	12 000	6 000	0,4	▶ 61916-2RZ	–
	110	16	25,1	20,4	1,02	12 000	7 500	0,38	▶ 61916	–
	125	14	35,1	31,5	1,32	11 000	7 000	0,61	▶ 16016	–
	125	22	49,4	40	1,66	11 000	7 000	0,86	▶ 6016	–
	125	22	49,4	40	1,66	–	3 200	0,88	▶ 6016-2RS1	6016-RS1
	125	22	49,4	40	1,66	11 000	5 600	0,89	▶ 6016-2Z	6016-Z
	140	26	72,8	55	2,2	9 500	6 000	1,45	▶ 6216	–
	140	26	72,8	55	2,2	9 500	8 500	1,7	6216 M	–
	140	26	72,8	55	2,2	–	3 000	1,5	▶ 6216-2RS1	6216-RS1

SKF Explorer bearing

▶ Popular item

¹⁾ For bearings with only one shield or one non-contact seal (Z, RZ) the limiting speeds of the open bearings are valid.

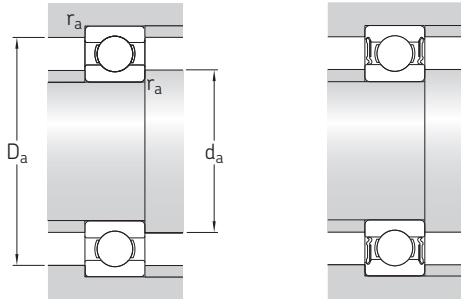

Dimensions						Abutment and fillet dimensions				Calculation factors	
d	d ₁ ≈	d ₂ ≈	D ₁ ≈	D ₂ ≈	r _{1,2} min.	d _a min.	d _a max.	D _a max.	r _a max.	k _r	f ₀
mm						mm				–	
75	81,7	–	–	90,7	1,3	79	81	91	0,6	0,015	13
	81,7	–	–	90,7	1,3	79	81	91	0,6	0,015	13
	81,7	–	–	90,7	1,3	79	–	91	0,6	0,015	13
	84,8	–	–	97,9	1,9	80	–	100	1	0,02	14
	84,7	–	–	98,3	1	80	84	100	1	0,02	17
	84,7	–	–	98,3	1	80	84	100	1	0,02	17
	88,3	–	102	–	0,6	79	–	111	0,6	0,02	16
	87,8	–	–	105	1,1	81	–	109	1	0,025	16
	87,8	–	–	105	1,1	81	–	109	1	0,025	16
	87,8	–	–	105	1,1	81	87	109	1	0,025	16
	87,8	–	–	105	1,1	81	87	109	1	0,025	16
	87,8	–	–	105	1,1	81	87	109	1	0,025	16
	92	–	–	117	1,5	84	–	121	1,5	0,025	15
	92	–	–	117	1,5	84	–	121	1,5	0,025	15
	92	–	–	117	1,5	84	92	121	1,5	0,025	15
92	–	–	117	1,5	84	92	121	1,5	0,025	15	
101	–	–	139	2,1	87	–	148	2	0,03	13	
101	–	–	139	2,1	87	–	148	2	0,03	13	
101	–	–	139	2,1	87	100	148	2	0,03	13	
101	–	–	139	2,1	87	100	148	2	0,03	13	
110	–	155	–	3	91	–	174	2,5	0,035	12	
80	86,7	–	–	95,7	1,3	84	86	96	0,6	0,015	13
	86,7	–	–	95,7	1,3	84	–	96	0,6	0,015	13
	89,8	–	–	103	1	85	89	105	1	0,02	14
	89,8	–	–	103	1	85	89	105	1	0,02	14
	89,8	–	–	103	1	85	–	105	1	0,02	14
	95,3	–	110	–	0,6	84	–	121	0,6	0,02	16
	94,4	–	–	115	1,1	86	–	119	1	0,025	16
	94,4	–	–	115	1,1	86	94	119	1	0,025	16
	94,4	–	–	115	1,1	86	94	119	1	0,025	16
	101	–	–	127	2	91	–	129	2	0,025	15
	101	–	–	127	2	91	–	129	2	0,025	15
	101	–	–	127	2	91	100	129	2	0,025	15

1.1 Single row deep groove ball bearings

d 80 – 90 mm

1.1

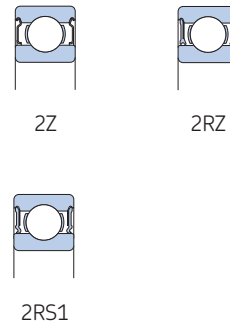
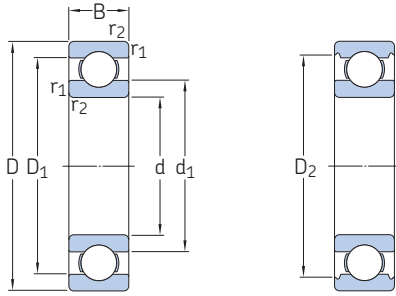

Principal dimensions			Basic load ratings		Fatigue load limit	Speed ratings		Mass	Designations	
d	D	B	dynamic	static		Reference speed	Limiting speed ¹⁾		Bearing open or capped on both sides	capped on one side ¹⁾
mm			kN		kN	r/min		kg	–	
80 cont.	140	26	72,8	55	2,2	9 500	4 800	1,55	▶ 6216-2Z	6216-Z
	170	39	130	86,5	3,25	8 500	7 500	4,4	▶ 6316 M	–
	170	39	130	86,5	3,25	8 500	5 300	3,65	▶ 6316	–
	170	39	130	86,5	3,25	–	2 600	3,7	▶ 6316-2RS1	6316-RS1
	170	39	130	86,5	3,25	8 500	4 300	3,75	▶ 6316-2Z	6316-Z
	200	48	163	125	4,5	7 500	4 800	6,85	▶ 6416	–
85	110	13	19,5	16,6	0,88	–	3 400	0,28	▶ 61817-2RS1	–
	110	13	19,5	16,6	0,88	12 000	6 000	0,28	▶ 61817-2RZ	–
	110	13	19,5	16,6	0,88	12 000	7 500	0,26	▶ 61817	–
	120	18	31,9	30	1,25	11 000	7 000	0,55	▶ 61917	–
	130	14	35,8	33,5	1,37	11 000	6 700	0,64	▶ 16017	–
	130	22	52	43	1,76	11 000	6 700	0,9	▶ 6017	–
	130	22	52	43	1,76	–	3 000	0,93	▶ 6017-2RS1	6017-RS1
	130	22	52	43	1,76	11 000	5 300	0,94	▶ 6017-2Z	6017-Z
	150	28	87,1	64	2,5	9 000	8 000	2	▶ 6217 M	–
	150	28	87,1	64	2,5	9 000	5 600	1,8	▶ 6217	–
	150	28	87,1	64	2,5	–	2 800	1,9	▶ 6217-2RS1	6217-RS1
	150	28	87,1	64	2,5	9 000	4 500	1,9	▶ 6217-2Z	6217-Z
	180	41	140	96,5	3,55	8 000	5 000	4,25	▶ 6317	–
	180	41	140	96,5	3,55	8 000	7 500	5,2	▶ 6317 M	–
	180	41	140	96,5	3,55	–	2 400	4,35	▶ 6317-2RS1	6317-RS1
180	41	140	96,5	3,55	8 000	4 000	4,4	▶ 6317-2Z	6317-Z	
210	52	174	137	4,75	7 000	4 500	8,05	▶ 6417	–	
90	115	13	19,5	17	0,915	–	3 200	0,29	▶ 61818-2RS1	–
	115	13	19,5	17	0,915	11 000	5 600	0,29	▶ 61818-2RZ	–
	115	13	19,5	17	0,915	11 000	7 000	0,28	▶ 61818	–
	125	18	33,2	31,5	1,29	11 000	6 700	0,59	▶ 61918	–
	140	16	43,6	39	1,56	10 000	6 300	0,85	▶ 16018	–
	140	24	60,5	50	1,96	10 000	8 500	1,35	▶ 6018 M	–
	140	24	60,5	50	1,96	10 000	6 300	1,15	▶ 6018	–
	140	24	60,5	50	1,96	–	2 800	1,2	▶ 6018-2RS1	6018-RS1
	140	24	60,5	50	1,96	10 000	5 000	1,2	▶ 6018-2Z	6018-Z
	160	30	101	73,5	2,8	8 500	5 300	2,2	▶ 6218	–
	160	30	101	73,5	2,8	8 500	5 300	2,65	▶ 6218 M	–
	160	30	101	73,5	2,8	–	2 600	2,3	▶ 6218-2RS1	6218-RS1

SKF Explorer bearing

▶ Popular item

¹⁾ For bearings with only one shield or one non-contact seal (Z, RZ) the limiting speeds of the open bearings are valid.

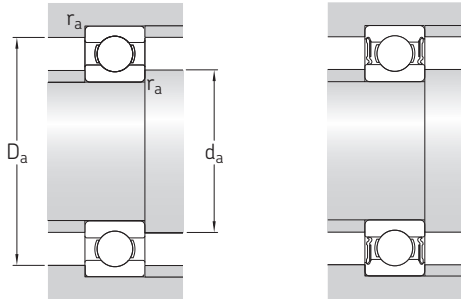

Dimensions						Abutment and fillet dimensions				Calculation factors	
d	d ₁ ≈	d ₂ ≈	D ₁ ≈	D ₂ ≈	r _{1,2} min.	d _a min.	d _a max.	D _a max.	r _a max.	k _r	f ₀
mm						mm				–	
80 cont.	101	–	–	127	2	91	100	129	2	0,025	15
	108	–	–	147	2,1	92	–	158	2	0,03	13
	108	–	–	147	2,1	92	–	158	2	0,03	13
	108	–	–	147	2,1	92	107	158	2	0,03	13
	108	–	–	147	2,1	92	107	158	2	0,03	13
	116	–	163	–	–	3	96	–	184	2,5	0,035
85	93,3	–	–	105	1,9	90	93	105	1	0,015	14
	93,3	–	–	105	1,9	90	93	105	1	0,015	14
	93,3	–	–	105	1,9	90	–	105	1	0,015	14
	96,4	–	109	–	1,1	91	–	114	1	0,02	16
	100	–	115	–	0,6	89	–	126	0,6	0,02	17
	99,4	–	–	120	1,1	92	–	123	1	0,025	16
	99,4	–	–	120	1,1	92	99	123	1	0,025	16
	99,4	–	–	120	1,1	92	99	123	1	0,025	16
	106	–	–	135	2	96	–	139	2	0,025	15
	106	–	–	135	2	96	–	139	2	0,025	15
	106	–	–	135	2	96	105	139	2	0,025	15
	106	–	–	135	2	96	105	139	2	0,025	15
	114	–	–	156	3	99	–	166	2,5	0,03	13
	114	–	–	156	3	99	–	166	2,5	0,03	13
	114	–	–	156	3	99	114	166	2,5	0,03	13
	114	–	–	156	3	99	114	166	2,5	0,03	13
	123	–	172	–	4	105	–	190	3	0,035	12
	90	98,3	–	–	110	1	95	98	110	1	0,015
98,3		–	–	110	1	95	98	110	1	0,015	13
98,3		–	–	110	1	95	–	110	1	0,015	13
101		–	114	–	1,1	96	–	119	1	0,02	17
106		–	124	–	1	95	–	135	1	0,02	16
105		–	–	129	1,5	97	–	133	1,5	0,025	16
105		–	–	129	1,5	97	–	133	1,5	0,025	16
105		–	–	129	1,5	97	105	133	1,5	0,025	16
105		–	–	129	1,5	97	105	133	1,5	0,025	16
112		–	–	143	2	101	–	149	2	0,025	15
112		–	–	143	2	101	–	149	2	0,025	15
112		–	–	143	2	101	112	149	2	0,025	15

1.1 Single row deep groove ball bearings

d 90 – 100 mm

1.1

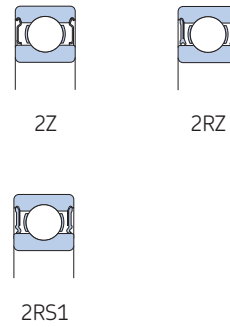
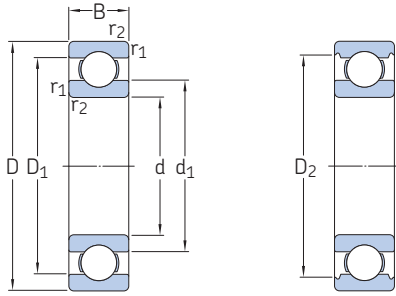

Principal dimensions			Basic load ratings		Fatigue load limit	Speed ratings		Mass	Designations		
d	D	B	C	C ₀		Reference speed	Limiting speed ¹⁾		Bearing open or capped on both sides	capped on one side ¹⁾	
mm			kN		kN	r/min	kg	–			
90 cont.	160	30	101	73,5	2,8	8 500	4 300	2,3	▶ 6218-Z	6218-Z	
	190	43	151	108	3,8	7 500	7 000	6,1	▶ 6318 M	–	
	190	43	151	108	3,8	7 500	4 800	4,95	▶ 6318	–	
	190	43	151	108	3,8	–	2 400	5,1	▶ 6318-2RS1	6318-RS1	
	190	43	151	108	3,8	7 500	3 800	5,15	▶ 6318-2Z	6318-Z	
	225	54	186	150	5	6 700	4 300	9,8	6418	–	
	120	13	19,9	17,6	0,93	–	3 000	0,31	▶ 61819-2RS1	–	
	120	13	19,9	17,6	0,93	11 000	6 700	0,29	▶ 61819	–	
	130	18	33,8	33,5	1,34	–	3 000	0,65	61919-2RS1	–	
95	130	18	33,8	33,5	1,34	10 000	6 300	0,61	61919	–	
	145	16	44,9	41,5	1,63	9 500	6 000	0,89	▶ 16019	–	
	145	24	63,7	54	2,08	9 500	6 000	1,2	▶ 6019	–	
	145	24	63,7	54	2,08	–	2 800	1,25	▶ 6019-2RS1	–	
	145	24	63,7	54	2,08	9 500	4 800	1,25	▶ 6019-2Z	6019-Z	
	170	32	114	81,5	3	8 000	5 000	2,65	▶ 6219	–	
	170	32	114	81,5	3	8 000	5 000	3,2	6219 M	–	
	170	32	114	81,5	3	–	2 400	2,7	▶ 6219-2RS1	6219-RS1	
	170	32	114	81,5	3	8 000	4 000	2,7	▶ 6219-2Z	6219-Z	
	200	45	159	118	4,15	7 000	4 500	5,75	▶ 6319	–	
	200	45	159	118	4,15	7 000	6 300	7,05	6319 M	–	
	200	45	159	118	4,15	–	2 200	5,85	▶ 6319-2RS1	6319-RS1	
	200	45	159	118	4,15	7 000	3 600	5,85	▶ 6319-2Z	6319-Z	
	100	125	13	17,8	18,3	0,95	–	3 000	0,32	▶ 61820-2RS1	–
		125	13	17,8	18,3	0,95	10 000	5 300	0,32	▶ 61820-2RZ	–
125		13	17,8	18,3	0,95	10 000	6 300	0,3	▶ 61820	–	
140		20	42,3	41,5	1,63	9 500	6 000	0,83	61920	–	
150		16	46,2	44	1,7	9 500	5 600	0,94	▶ 16020	–	
150		24	63,7	54	2,04	9 500	7 500	1,45	6020 M	–	
150		24	63,7	54	2,04	9 500	5 600	1,25	▶ 6020	–	
150		24	63,7	54	2,04	–	2 600	1,3	▶ 6020-2RS1	6020-RS1	
150		24	63,7	54	2,04	9 500	4 500	1,3	▶ 6020-2Z	6020-Z	
180		34	127	93	3,35	7 500	4 800	3,2	▶ 6220	–	
180		34	127	93	3,35	7 500	7 000	3,8	6220 M	–	
180		34	127	93	3,35	–	2 400	3,3	▶ 6220-2RS1	6220-RS1	

SKF Explorer bearing

▶ Popular item

¹⁾ For bearings with only one shield or one non-contact seal (Z, RZ) the limiting speeds of the open bearings are valid.

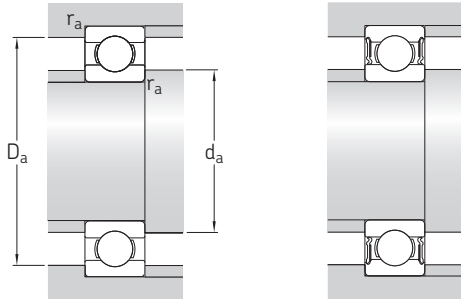

Dimensions						Abutment and fillet dimensions				Calculation factors		
d	d ₁ ≈	d ₂ ≈	D ₁ ≈	D ₂ ≈	r _{1,2} min.	d _a min.	d _a max.	D _a max.	r _a max.	k _r	f ₀	
mm						mm				–		
90 cont.	112	–	–	143	2	101	112	149	2	0,025	15	
	121	–	–	164	3	104	–	176	2,5	0,03	13	
	121	–	–	164	3	104	–	176	2,5	0,03	13	
	121	–	–	164	3	104	120	176	2,5	0,03	13	
	121	–	–	164	3	104	120	176	2,5	0,03	13	
	132	–	181	–	4	110	–	205	3	0,035	13	
95	103	–	–	115	1	100	102	115	1	0,015	13	
	103	–	–	115	1	100	–	115	1	0,015	13	
	106	–	–	122	1,1	101	105	124	1	0,02	17	
	106	–	119	–	1,1	101	–	124	1	0,02	17	
	111	–	129	–	1	100	–	140	1	0,02	16	
	111	–	–	134	1,5	102	–	138	1,5	0,025	16	
	111	–	–	134	1,5	102	111	138	1,5	0,025	16	
	111	–	–	134	1,5	102	111	138	1,5	0,025	16	
	118	–	–	152	2,1	107	–	158	2	0,025	14	
	118	–	–	152	2,1	107	–	158	2	0,025	14	
	118	–	–	152	2,1	107	118	158	2	0,025	14	
	118	–	–	152	2,1	107	118	158	2	0,025	14	
	127	–	–	172	3	109	–	186	2,5	0,03	13	
	127	–	–	172	3	109	–	186	2,5	0,03	13	
	127	–	–	172	3	109	127	186	2,5	0,03	13	
	127	–	–	172	3	109	127	186	2,5	0,03	13	
	100	108	–	–	120	1	105	107	120	1	0,015	13
		108	–	–	120	1	105	107	120	1	0,015	13
108		–	–	120	1	105	–	120	1	0,015	13	
112		–	128	–	1,1	106	–	134	1	0,02	16	
116		–	134	–	1	105	–	145	1	0,02	17	
115		–	–	139	1,5	107	–	143	1,5	0,025	16	
115		–	–	139	1,5	107	–	143	1,5	0,025	16	
115		–	–	139	1,5	107	115	143	1,5	0,025	16	
115		–	–	139	1,5	107	115	143	1,5	0,025	16	
124		–	–	160	2,1	112	–	168	2	0,025	14	
124		–	–	160	2,1	112	–	168	2	0,025	14	
124		–	–	160	2,1	112	124	168	2	0,025	14	

1.1 Single row deep groove ball bearings

d 100 – 110 mm

1.1

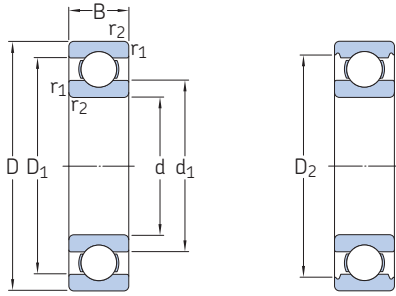

2Z

2RZ



2RS1

Principal dimensions			Basic load ratings		Fatigue load limit	Speed ratings		Mass	Designations	
d	D	B	dynamic	static		Reference speed	Limiting speed ¹⁾		Bearing open or capped on both sides	capped on one side ¹⁾
mm			kN		kN	r/min	kg	–		
100 cont.	180	34	127	93	3,35	7 500	3 800	3,3	▶ 6220-2Z	6220-Z
	215	47	174	140	4,75	6 700	4 300	7,1	▶ 6320	–
	215	47	174	140	4,75	6 700	6 000	8,7	▶ 6320 M	–
	215	47	174	140	4,75	–	2 000	7,2	▶ 6320-2RS1	6320-RS1
	215	47	174	140	4,75	6 700	3 400	7,3	▶ 6320-2Z	6320-Z
105	130	13	20,8	19,6	1	–	2 800	0,33	▶ 61821-2RS1	–
	130	13	20,8	19,6	1	10 000	5 000	0,33	▶ 61821-2RZ	–
	130	13	20,8	19,6	1	10 000	6 300	0,31	▶ 61821	–
	145	20	44,2	44	1,7	9 500	5 600	0,87	▶ 61921	–
	160	18	54	51	1,86	8 500	5 300	1,2	▶ 16021	–
	160	26	76,1	65,5	2,4	8 500	5 300	1,6	▶ 6021	–
	160	26	76,1	65,5	2,4	8 500	7 500	1,85	▶ 6021 M	–
	160	26	76,1	65,5	2,4	–	2 400	1,65	▶ 6021-2RS1	6021-RS1
	160	26	76,1	65,5	2,4	8 500	4 300	1,65	▶ 6021-2Z	6021-Z
	190	36	140	104	3,65	7 000	4 500	3,8	▶ 6221	–
190	36	140	104	3,65	7 000	3 600	3,9	▶ 6221-2Z	6221-Z	
	225	49	182	153	5,1	6 300	3 200	8,25	▶ 6321-2Z	6321-Z
	225	49	182	153	5,1	6 300	4 000	8,2	▶ 6321	–
110	140	16	28,1	26	1,25	–	2 600	0,6	▶ 61822-2RS1	–
	140	16	28,1	26	1,25	9 500	4 500	0,6	▶ 61822-2RZ	–
	140	16	28,1	26	1,25	9 500	5 600	0,47	▶ 61822	–
	150	20	43,6	45	1,66	9 000	5 600	0,9	▶ 61922	–
	150	20	43,6	45	1,66	9 000	7 500	1,05	▶ 61922 MA	–
	170	19	60,5	57	2,04	8 000	5 000	1,45	▶ 16022	–
	170	28	85,2	73,5	2,6	8 000	5 000	1,95	▶ 6022	–
	170	28	85,2	73,5	2,6	8 000	7 000	2,3	▶ 6022 M	–
	170	28	85,2	73,5	2,6	–	2 400	2	▶ 6022-2RS1	6022-RS1
	170	28	85,2	73,5	2,6	8 000	4 000	2,05	▶ 6022-2Z	6022-Z
	200	38	151	118	4	6 700	4 300	4,45	▶ 6222	–
	200	38	151	118	4	–	2 000	4,6	▶ 6222-2RS1	6222-RS1
	200	38	151	118	4	6 700	3 400	4,6	▶ 6222-2Z	6222-Z
	240	50	203	180	5,7	6 000	3 800	9,65	▶ 6322	–
240	50	203	180	5,7	6 000	5 300	11,5	▶ 6322 M	–	

SKF Explorer bearing

▶ Popular item

¹⁾ For bearings with only one shield or one non-contact seal (Z, RZ) the limiting speeds of the open bearings are valid.

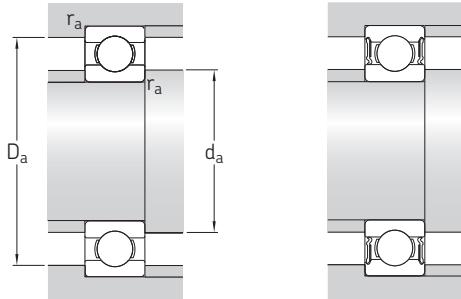

Dimensions						Abutment and fillet dimensions				Calculation factors	
d	d ₁ ≈	d ₂ ≈	D ₁ ≈	D ₂ ≈	r _{1,2} min.	d _a min.	d _a max.	D _a max.	r _a max.	k _r	f ₀
mm						mm				–	
100 cont.	124	–	–	160	2,1	112	124	168	2	0,025	14
	135	–	–	184	3	114	–	201	2,5	0,03	13
	135	–	–	184	3	114	–	201	2,5	0,03	13
	135	–	–	184	3	114	135	201	2,5	0,03	13
	135	–	–	184	3	114	135	201	2,5	0,03	13
	135	–	–	184	3	114	135	201	2,5	0,03	13
105	112	–	–	125	1	110	112	125	1	0,015	13
	112	–	–	125	1	110	112	125	1	0,015	13
	112	–	–	125	1	110	–	125	1	0,015	13
	117	–	133	–	1,1	111	–	139	1	0,02	17
	123	–	142	–	1	110	–	155	1	0,02	16
	122	–	–	147	2	116	–	149	2	0,025	16
	122	–	–	147	2	116	–	149	2	0,025	16
	122	–	–	147	2	116	122	149	2	0,025	16
	122	–	–	147	2	116	122	149	2	0,025	16
	131	–	–	167	2,1	117	–	178	2	0,025	14
	131	–	–	167	2,1	117	131	178	2	0,025	14
	141	–	–	194	3	119	140	211	2,5	0,03	13
141	–	188	–	3	119	–	211	2,5	0,03	13	
110	118	–	–	135	1	115	118	135	1	0,015	14
	118	–	–	135	1	115	118	135	1	0,015	14
	118	–	–	135	1	115	–	135	1	0,015	14
	122	–	138	–	1,1	116	–	144	1	0,02	17
	122	–	–	81,5	1,1	116	–	144	1	0,02	17
	130	–	150	–	1	115	–	165	1	0,02	16
	129	–	–	156	2	119	–	161	2	0,025	16
	129	–	–	156	2	119	–	161	2	0,025	16
	129	–	–	156	2	119	128	161	2	0,025	16
	129	–	–	156	2	119	128	161	2	0,025	16
	138	–	–	177	2,1	122	–	188	2	0,025	14
	138	–	–	177	2,1	122	137	188	2	0,025	14
	138	–	–	177	2,1	122	137	188	2	0,025	14
	149	–	200	–	3	124	–	226	2,5	0,03	13
	149	–	200	–	3	124	–	226	2,5	0,03	13

1.1 Single row deep groove ball bearings

d 120 – 130 mm

1.1

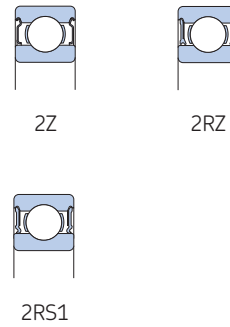
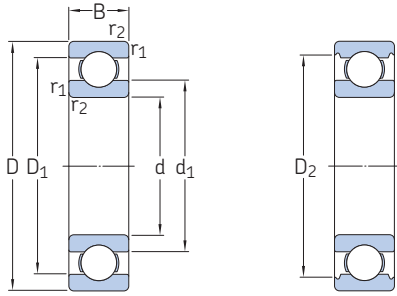

Principal dimensions			Basic load ratings		Fatigue load limit	Speed ratings		Mass	Designations	
d	D	B	dynamic	static		Reference speed	Limiting speed ¹⁾		Bearing open or capped on both sides	capped on one side ¹⁾
mm			kN		kN	r/min	kg	–		
120	150	16	29,1	28	1,29	–	2 400	0,65	▶ 61824-2RS1	–
	150	16	29,1	28	1,29	8 500	4 300	0,65	▶ 61824-2RZ	–
	150	16	29,1	28	1,29	8 500	5 300	0,51	▶ 61824	–
	165	22	55,3	57	2,04	8 000	5 000	1,2	61924	–
	165	22	55,3	57	2,04	8 000	6 700	1,4	61924 MA	–
	180	19	63,7	64	2,2	7 500	4 800	1,55	▶ 16024	–
	180	28	88,4	80	2,75	7 500	6 300	2,45	6024 MA	–
	180	28	88,4	80	2,75	7 500	4 800	2,1	▶ 6024	–
	180	28	88,4	80	2,75	–	2 200	2,15	▶ 6024-2RS1	6024-RS1
	180	28	88,4	80	2,75	7 500	3 800	2,2	▶ 6024-2Z	6024-Z
	215	40	146	118	3,9	6 300	4 000	5,25	▶ 6224	–
	215	40	146	118	3,9	6 300	5 600	6,1	▶ 6224 M	–
	215	40	146	118	3,9	–	1 900	5,35	▶ 6224-2RS1	6224-RS1
	215	40	146	118	3,9	6 300	3 200	5,35	6224-2Z	6224-Z
	260	55	208	186	5,7	5 600	3 400	12,5	▶ 6324	–
260	55	208	186	5,7	5 600	5 000	14	▶ 6324 M	–	
260	55	208	186	5,7	–	1 700	12,5	▶ 6324-2RS1	6324-RS1	
260	55	208	186	5,7	5 600	2 800	12,5	6324-2Z	6324-Z	
130	165	18	37,7	43	1,6	–	2 200	0,93	▶ 61826-2RS1	–
	165	18	37,7	43	1,6	8 000	3 800	0,93	▶ 61826-2RZ	–
	165	18	37,7	43	1,6	8 000	4 800	0,75	▶ 61826	–
	180	24	65	67	2,28	7 500	4 500	1,6	▶ 61926	–
	200	22	83,2	81,5	2,7	7 000	4 300	2,35	▶ 16026	–
	200	33	112	100	3,35	7 000	5 600	3,75	6026 M	–
	200	33	112	100	3,35	7 000	4 300	3,3	▶ 6026	–
	200	33	112	100	3,35	–	2 000	3,3	▶ 6026-2RS1	6026-RS1
	200	33	112	100	3,35	7 000	3 400	3,35	▶ 6026-2Z	6026-Z
	230	40	156	132	4,15	5 600	5 300	6,95	6226 M	–
	230	40	156	132	4,15	5 600	3 600	5,85	▶ 6226	–
	230	40	156	132	4,15	–	1 800	6	▶ 6226-2RS1	6226-RS1
	230	40	156	132	4,15	5 600	3 000	6	▶ 6226-2Z	6226-Z
	280	58	229	216	6,3	5 000	3 200	15	▶ 6326	–
	280	58	229	216	6,3	5 000	4 500	17,5	▶ 6326 M	–

SKF Explorer bearing

▶ Popular item

¹⁾ For bearings with only one shield or one non-contact seal (Z, RZ) the limiting speeds of the open bearings are valid.

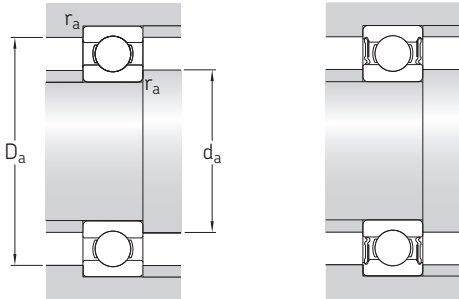

Dimensions						Abutment and fillet dimensions				Calculation factors	
d	d ₁ ≈	d ₂ ≈	D ₁ ≈	D ₂ ≈	r _{1,2} min.	d _a min.	d _a max.	D _a max.	r _a max.	k _r	f ₀
mm						mm				–	
120	128	–	–	145	1	125	128	145	1	0,015	14
	128	–	–	145	1	125	128	145	1	0,015	14
	128	–	–	145	1	125	–	145	1	0,015	14
	134	–	151	–	1,1	126	–	159	1	0,02	17
	134	–	152	–	1,1	126	–	159	1	0,02	17
	139	–	161	–	1	125	–	175	1	0,02	17
	139	–	–	166	2	129	–	171	2	0,025	16
	139	–	–	166	2	129	–	171	2	0,025	16
	139	–	–	166	2	129	139	171	2	0,025	16
	139	–	–	166	2	129	139	171	2	0,025	16
	150	–	185	–	2,1	132	–	203	2	0,025	14
	150	–	185	–	2,1	132	–	203	2	0,025	14
	150	–	–	190	2,1	132	150	203	2	0,025	14
	150	–	–	190	2,1	132	150	203	2	0,025	14
	164	–	215	–	3	134	–	246	2,5	0,03	14
164	–	215	–	3	134	–	246	2,5	0,03	14	
164	–	–	221	3	134	164	246	2,5	0,03	14	
164	–	–	221	3	134	164	246	2,5	0,03	14	
130	140	–	–	158	1,1	136	139	159	1	0,015	16
	140	–	–	158	1,1	136	139	159	1	0,015	16
	140	–	–	158	1,1	136	–	159	1	0,015	16
	145	–	164	–	1,5	137	–	173	1,5	0,02	16
	153	–	176	–	1,1	136	–	192	1	0,02	16
	152	–	–	182	2	139	–	191	2	0,025	16
	152	–	–	182	2	139	–	191	2	0,025	16
	152	–	–	182	2	139	152	191	2	0,025	16
	152	–	–	182	2	139	152	191	2	0,025	16
	160	–	198	–	3	144	–	216	2,5	0,025	15
	160	–	198	–	3	144	–	216	2,5	0,025	15
	160	–	–	203	3	144	160	216	2,5	0,025	15
	160	–	–	203	3	144	160	216	2,5	0,025	15
	177	–	232	–	4	147	–	263	3	0,03	14
	177	–	232	–	4	147	–	263	3	0,03	14

1.1 Single row deep groove ball bearings

d 140 – 160 mm

1.1

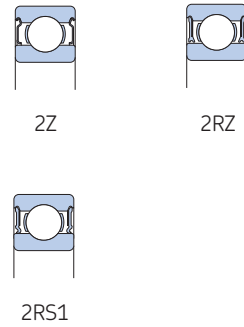
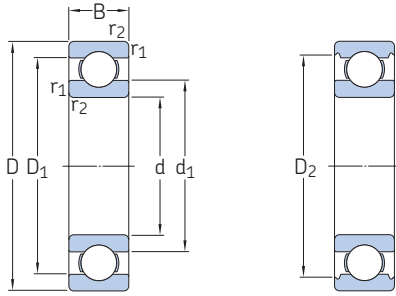

Principal dimensions			Basic load ratings		Fatigue load limit	Speed ratings		Mass	Designations	
d	D	B	dynamic	static		Reference speed	Limiting speed ¹⁾		Bearing open or capped on both sides	capped on one side ¹⁾
mm			kN		kN	r/min	kg	–		
140	175	18	39	46,5	1,66	–	2 000	0,99	61828-2RS1	–
	175	18	39	46,5	1,66	7 500	3 600	0,99	▶ 61828-2RZ	–
	175	18	39	46,5	1,66	7 500	4 500	0,82	▶ 61828	–
	190	24	66,3	72	2,36	7 000	4 300	1,7	61928	–
	190	24	66,3	72	2,36	7 000	5 600	2	▶ 61928 MA	–
	210	22	80,6	86,5	2,8	6 700	4 000	2,55	▶ 16028	–
	210	33	111	108	3,45	6 700	5 300	4	▶ 6028 M	–
	210	33	111	108	3,45	6 700	4 000	3,45	▶ 6028	–
	210	33	111	108	3,45	–	1 800	3,55	▶ 6028-2RS1	6028-RS1
	210	33	111	108	3,45	6 700	3 200	3,55	▶ 6028-2Z	6028-Z
	250	42	165	150	4,55	5 300	3 400	7,75	▶ 6228	–
	250	42	165	150	4,55	5 300	4 800	9,4	6228 MA	–
150	300	62	251	245	7,1	4 800	3 000	18,5	▶ 6328	–
	300	62	251	245	7,1	4 800	4 300	21	▶ 6328 M	–
	190	20	48,8	61	1,96	6 700	4 300	1,2	▶ 61830	–
	190	20	48,8	61	1,96	6 700	4 300	1,35	▶ 61830 MA	–
	210	28	88,4	93	2,9	6 300	5 300	3,05	61930 MA	–
	225	24	92,2	98	3,05	6 000	3 800	3,15	▶ 16030	–
	225	35	125	125	3,9	6 000	5 000	4,9	▶ 6030 M	–
	225	35	125	125	3,9	6 000	3 800	4,3	▶ 6030	–
	225	35	125	125	3,9	–	1 700	4,35	▶ 6030-2RS1	6030-RS1
	225	35	125	125	3,9	6 000	3 000	4,4	▶ 6030-2Z	6030-Z
	270	45	174	166	4,9	5 000	3 200	10	▶ 6230	–
	270	45	174	166	4,9	5 000	4 500	11,5	▶ 6230 M	–
160	320	65	276	285	7,8	4 300	2 800	23	▶ 6330	–
	320	65	276	285	7,8	4 300	4 000	25,5	▶ 6330 M	–
	200	20	49,4	64	2	6 300	4 000	1,25	▶ 61832	–
	220	28	92,3	98	3,05	6 000	3 800	2,7	61932	–
	220	28	92,3	98	3,05	6 000	5 000	3,2	▶ 61932 MA	–
	240	25	99,5	108	3,25	5 600	3 600	3,65	▶ 16032	–
	240	38	143	143	4,3	5 600	4 800	6	▶ 6032 M	–
	240	38	143	143	4,3	5 600	3 600	5,2	▶ 6032	–
	240	38	143	143	4,3	–	1 600	5,3	▶ 6032-2RS1	6032-RS1
	240	38	143	143	4,3	5 600	2 800	5,4	▶ 6032-2Z	6032-Z
	290	48	186	186	5,3	4 500	3 000	13	▶ 6232	–

▶ Popular item

¹⁾ For bearings with only one shield or one non-contact seal (Z, RZ) the limiting speeds of the open bearings are valid.

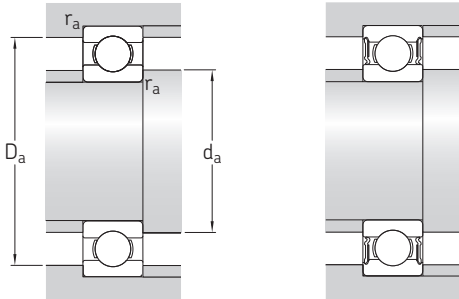

Dimensions						Abutment and fillet dimensions				Calculation factors		
d	d ₁ ≈	d ₂ ≈	D ₁ ≈	D ₂ ≈	r _{1,2} min.	d _a min.	d _a max.	D _a max.	r _a max.	k _r	f ₀	
mm						mm				–		
140	150	–	–	167	1,1	146	150	169	1	0,015	16	
	150	–	–	167	1,1	146	150	169	1	0,015	16	
	150	–	–	167	2,5	146	–	169	1	0,015	16	
	156	–	174	–	1,5	147	–	183	1,5	0,02	15	
	156	–	175	–	1,5	147	–	183	1,5	0,02	17	
	163	–	186	–	1,1	146	–	204	1	0,02	17	
	162	–	–	192	2	149	–	201	2	0,025	16	
	162	–	–	192	2	149	–	201	2	0,025	16	
	162	–	–	192	2	149	162	201	2	0,025	16	
	162	–	–	192	2	149	162	201	2	0,025	16	
	175	–	213	–	3	154	–	236	2,5	0,025	15	
	175	–	214	–	3	154	–	236	2,5	0,025	15	
	190	–	249	–	4	157	–	283	3	0,03	14	
	190	–	249	–	4	157	–	283	3	0,03	14	
	150	162	–	178	–	2,5	156	–	184	1	0,015	17
162		–	178	–	1,1	156	–	184	1	0,015	17	
169		–	192	–	2	159	–	201	2	0,02	16	
174		–	200	–	1,1	156	–	219	1	0,02	17	
174		–	–	206	2,1	160	–	215	2	0,025	16	
174		–	–	206	2,1	160	–	215	2	0,025	16	
174		–	–	206	2,1	160	173	215	2	0,025	16	
174		–	–	206	2,1	160	173	215	2	0,025	16	
190		–	228	–	3	164	–	256	2,5	0,025	15	
190		–	228	–	3	164	–	256	2,5	0,025	15	
205		–	264	–	4	167	–	303	3	0,03	14	
205		–	264	–	4	167	–	303	3	0,03	14	
160		172	–	188	–	1,1	166	–	194	1	0,015	17
		179	–	201	–	2	169	–	211	2	0,02	17
		179	–	202	–	2	169	–	211	2	0,02	17
	185	–	214	–	1,5	167	–	233	1,5	0,02	17	
	185	–	–	219	2,1	169	–	231	2	0,025	16	
	185	–	–	219	2,1	169	–	231	2	0,025	16	
	185	–	–	219	2,1	169	185	231	2	0,025	16	
	185	–	–	219	2,1	169	185	231	2	0,025	16	
	205	–	243	–	3	174	–	276	2,5	0,025	15	

1.1 Single row deep groove ball bearings

d 160 – 200 mm

1.1

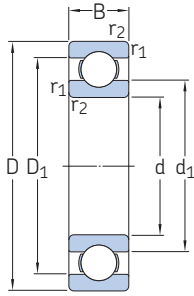

Principal dimensions			Basic load ratings		Fatigue load limit	Speed ratings		Mass	Designations	
d	D	B	dynamic	static		Reference speed	Limiting speed ¹⁾		Bearing open or capped on both sides	capped on one side ¹⁾
mm			kN		kN	r/min	kg	–		
160 cont.	290	48	186	186	5,3	4 500	4 300	14	▶ 6232 M	–
	340	68	276	285	7,65	4 000	2 600	26	▶ 6332	–
	340	68	276	285	7,65	4 000	3 800	30	▶ 6332 M	–
170	215	22	61,8	78	2,4	6 000	3 600	1,65	▶ 61834	–
	230	28	93,6	106	3,15	5 600	4 800	3,35	▶ 61934 MA	–
	260	28	119	129	3,75	5 300	3 200	5	▶ 16034	–
	260	42	168	173	5	5 300	3 200	7	▶ 6034	–
	260	42	168	173	5	5 300	4 300	8,15	▶ 6034 M	–
	310	52	212	224	6,1	4 300	2 800	16	▶ 6234	–
	310	52	212	224	6,1	4 300	3 800	17,5	▶ 6234 M	–
	360	72	312	340	8,8	3 800	2 400	31	▶ 6334	–
	360	72	312	340	8,8	3 800	3 400	35	▶ 6334 M	–
	180	225	22	62,4	81,5	2,45	5 600	3 400	1,75	▶ 61836
250		33	119	134	3,9	5 300	3 200	5	▶ 61936	–
250		33	119	134	3,9	5 300	4 300	5	▶ 61936 MA	–
280		31	138	146	4,15	4 800	3 000	6,5	▶ 16036	–
280		46	190	200	5,6	4 800	3 000	9,1	▶ 6036	–
280		46	190	200	5,6	4 800	4 000	10,5	▶ 6036 M	–
320		52	229	240	6,4	4 000	2 600	16	▶ 6236	–
320		52	229	240	6,4	4 000	3 800	18	▶ 6236 M	–
380		75	351	405	10,4	3 600	2 200	36,5	▶ 6336	–
380		75	351	405	10,4	3 600	3 200	41	▶ 6336 M	–
190	240	24	76,1	98	2,8	5 300	3 200	2,25	▶ 61838	–
	260	33	117	134	3,8	5 000	3 200	4,5	▶ 61938	–
	260	33	117	134	3,8	5 000	4 300	5,2	▶ 61938 MA	–
	290	31	148	166	4,55	4 800	3 000	6,9	▶ 16038	–
	290	46	195	216	5,85	4 800	3 000	9,55	▶ 6038	–
	290	46	195	216	5,85	4 800	3 800	11	▶ 6038 M	–
	340	55	255	280	7,35	3 800	2 400	19,5	▶ 6238	–
	340	55	255	280	7,35	3 800	3 400	21,5	▶ 6238 M	–
	400	78	371	430	10,8	3 400	2 200	42	▶ 6338	–
	400	78	371	430	10,8	3 400	3 000	47,5	▶ 6338 M	–
200	250	24	76,1	102	2,9	5 000	3 200	2,35	▶ 61840	–
	280	38	148	166	4,55	4 800	3 000	6,3	▶ 61940	–
	280	38	148	166	4,55	4 800	3 800	7,3	▶ 61940 MA	–

▶ Popular item

¹⁾ For bearings with only one shield or one non-contact seal (Z, RZ) the limiting speeds of the open bearings are valid.

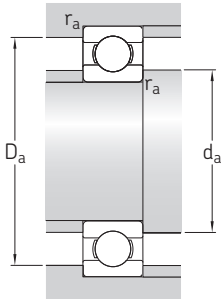

Dimensions						Abutment and fillet dimensions				Calculation factors		
d	d ₁ ≈	d ₂ ≈	D ₁ ≈	D ₂ ≈	r _{1,2} min.	d _a min.	d _a max.	D _a max.	r _a max.	k _r	f ₀	
mm						mm				–		
160 cont.	205	–	243	–	3	174	–	276	2,5	0,025	15	
	218	–	281	–	4	177	–	323	3	0,03	14	
	218	–	281	–	4	177	–	323	3	0,03	14	
170	184	–	202	–	1,1	176	–	209	1	0,015	17	
	189	–	212	–	2	179	–	221	2	0,02	17	
	200	–	229	–	1,5	177	–	253	1,5	0,02	16	
	198	–	232	–	2,1	180	–	250	2	0,025	16	
	198	–	232	–	2,1	180	–	250	2	0,025	16	
	218	–	259	–	4	187	–	293	3	0,025	15	
	218	–	259	–	4	187	–	293	3	0,025	15	
	230	–	299	–	4	187	–	343	3	0,03	14	
	230	–	299	–	4	187	–	343	3	0,03	14	
	180	194	–	211	–	1,1	186	–	219	1	0,015	17
		202	–	228	–	2	189	–	241	2	0,02	17
		202	–	229	–	2	189	–	241	2	0,02	17
213		–	246	–	2	189	–	271	2	0,02	16	
212		–	248	–	2,1	190	–	270	2	0,025	16	
212		–	248	–	2,1	190	–	270	2	0,025	16	
226		–	274	–	4	197	–	303	3	0,025	15	
226		–	274	–	4	197	–	303	3	0,025	15	
244		–	315	–	4	197	–	363	3	0,03	14	
244		–	315	–	4	197	–	363	3	0,03	14	
190		206	–	224	–	1,5	197	–	233	1,5	0,015	17
		212	–	238	–	2	199	–	251	2	0,02	17
	212	–	239	–	2	199	–	251	2	0,02	17	
	223	–	256	–	2	199	–	281	2	0,02	16	
	222	–	258	–	2,1	200	–	280	2	0,025	16	
	222	–	258	–	2,1	200	–	280	2	0,025	16	
	239	–	290	–	4	207	–	323	3	0,025	15	
	239	–	290	–	4	207	–	323	3	0,025	15	
	259	–	331	–	5	210	–	380	4	0,03	14	
	259	–	331	–	5	210	–	380	4	0,03	14	
	200	216	–	234	–	1,5	207	–	243	1,5	0,015	17
		225	–	255	–	2,1	210	–	270	2	0,02	16
225		–	256	–	2,1	210	–	270	2	0,02	16	

1.1 Single row deep groove ball bearings d 200 – 260 mm

1.1

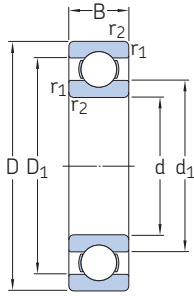

Principal dimensions			Basic load ratings		Fatigue load limit	Speed ratings		Mass	Designations		
d	D	B	dynamic	static		Reference speed	Limiting speed ¹⁾		Bearing open or capped on both sides	capped on one side ¹⁾	
mm			kN		kN	r/min	kg	–			
200 cont.	310	34	168	190	5,1	4 300	2 800	8,8	▶ 16040	–	
	310	51	216	245	6,4	4 300	2 800	12,5	6040	–	
	310	51	216	245	6,4	4 300	3 600	14	▶ 6040 M	–	
	360	58	270	310	7,8	3 600	2 200	23,5	6240	–	
	360	58	270	310	7,8	3 600	3 200	26	▶ 6240 M	–	
	220	270	24	78	110	3	4 500	2 800	2,55	▶ 61844	–
300		38	151	180	4,75	4 300	2 600	6,8	61944	–	
300		38	151	180	4,75	4 300	3 600	7,95	▶ 61944 MA	–	
340		37	174	204	5,2	4 000	2 400	11,5	▶ 16044	–	
340		56	247	290	7,35	4 000	2 400	16	6044	–	
340		56	247	290	7,35	4 000	3 200	18,5	▶ 6044 M	–	
400		65	296	365	8,8	3 200	2 000	33,5	6244	–	
400		65	296	365	8,8	3 200	3 000	36,5	▶ 6244 M	–	
460		88	410	520	12	3 000	2 600	73	▶ 6344 M	–	
240		300	28	108	150	3,8	4 000	2 600	3,9	▶ 61848	–
		320	38	159	200	5,1	4 000	2 400	7,3	61948	–
		320	38	159	200	5,1	4 000	3 200	8,55	▶ 61948 MA	–
	360	37	203	255	6,3	3 600	2 200	12,5	▶ 16048	–	
	360	37	203	255	6,3	3 600	3 000	14	▶ 16048 MA	–	
	360	56	255	315	7,8	3 600	2 200	17	6048	–	
	360	56	255	315	7,8	3 600	3 000	19,5	▶ 6048 M	–	
	440	72	358	465	10,8	3 000	2 600	51	▶ 6248 M	–	
	500	95	442	585	12,9	2 600	2 400	97	6348 M	–	
	260	320	28	111	163	4	3 800	2 400	4,15	▶ 61852	–
		360	46	212	270	6,55	3 600	2 200	12	61952	–
		360	46	212	270	6,55	3 600	3 000	14,5	▶ 61952 MA	–
400		44	238	310	7,2	3 200	2 000	18	16052	–	
400		44	238	310	7,2	3 200	2 800	22,5	▶ 16052 MA	–	
400		65	291	375	8,8	3 200	2 000	25	6052	–	
400		65	291	375	8,8	3 200	2 800	29	▶ 6052 M	–	
480		80	390	530	11,8	2 600	2 400	65,5	▶ 6252 M	–	

▶ Popular item

¹⁾ For bearings with only one shield or one non-contact seal (Z, RZ) the limiting speeds of the open bearings are valid.

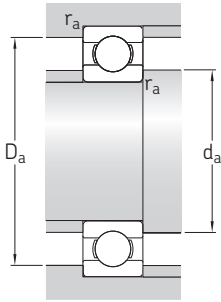

Dimensions						Abutment and fillet dimensions				Calculation factors	
d	d ₁ ≈	d ₂ ≈	D ₁ ≈	D ₂ ≈	r _{1,2} min.	d _a min.	d _a max.	D _a max.	r _a max.	k _r	f ₀
mm						mm				-	
200 cont.	237	-	273	-	2	209	-	301	2	0,02	16
	235	-	275	-	2,1	210	-	300	2	0,025	16
	235	-	275	-	2,1	210	-	300	2	0,025	16
	254	-	303	-	4	217	-	343	3	0,025	15
	254	-	303	-	4	217	-	343	3	0,025	15
220	236	-	254	-	1,5	227	-	263	1,5	0,015	17
	245	-	275	-	2,1	230	-	290	2	0,02	17
	245	-	276	-	2,1	230	-	290	2	0,02	17
	261	-	298	-	2,1	230	-	330	2	0,02	17
	258	-	302	-	3	233	-	327	2,5	0,025	16
	258	-	302	-	3	233	-	327	2,5	0,025	16
	282	-	335	-	4	237	-	383	3	0,025	15
	282	-	335	-	4	237	-	383	3	0,025	15
	301	-	379	-	5	240	-	440	4	0,03	14
240	259	-	281	-	2	249	-	291	2	0,015	17
	265	-	295	-	2,1	250	-	310	2	0,02	17
	265	-	296	-	2,1	250	-	310	2	0,02	17
	279	-	318	-	2,1	250	-	350	2	0,02	17
	279	-	321	-	2,1	250	-	350	2	0,02	17
	277	-	322	-	3	253	-	347	2,5	0,025	16
	277	-	322	-	3	253	-	347	2,5	0,025	16
	309	-	371	-	4	257	-	423	3	0,025	15
	331	-	409	-	5	260	-	480	4	0,03	15
260	279	-	301	-	2	269	-	311	2	0,015	17
	291	-	329	-	2,1	270	-	350	2	0,02	17
	291	-	330	-	2,1	270	-	350	2	0,02	17
	307	-	351	-	3	273	-	387	2,5	0,02	16
	307	-	353	-	3	273	-	387	2,5	0,02	16
	304	-	356	-	4	277	-	383	3	0,025	16
	304	-	356	-	4	277	-	383	3	0,025	16
	337	-	403	-	5	280	-	460	4	0,025	15

1.1 Single row deep groove ball bearings

d 280 – 380 mm

1.1

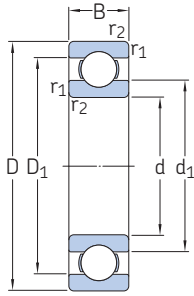

Principal dimensions			Basic load ratings		Fatigue load limit	Speed ratings		Mass	Designations	
d	D	B	dynamic	static		Reference speed	Limiting speed ¹⁾		Bearing open or capped on both sides	capped on one side ¹⁾
mm			kN		kN	r/min	kg	–		
280	350	33	138	200	4,75	3 400	2 200	6,25	▶ 61856	–
	350	33	138	200	4,75	3 400	2 800	7,25	▶ 61856 MA	–
	380	46	216	285	6,7	3 200	2 000	12	61956	–
	380	46	216	285	6,7	3 200	2 800	15,5	▶ 61956 MA	–
	420	44	242	335	7,5	3 000	1 900	19	16056	–
	420	44	242	335	7,5	3 000	2 600	23,5	▶ 16056 MA	–
	420	65	302	405	9,3	3 000	1 900	26	6056	–
	420	65	302	405	9,3	3 000	2 600	31	▶ 6056 M	–
	500	80	423	600	12,9	2 600	2 200	72	6256 M	–
	300	380	38	172	245	5,6	3 200	2 000	8,9	▶ 61860
380		38	172	245	5,6	3 200	2 600	10,5	▶ 61860 MA	–
420		56	270	375	8,3	3 000	1 900	19	61960	–
420		56	270	375	8,3	3 000	2 400	24,5	▶ 61960 MA	–
460		50	286	405	8,8	2 800	1 800	32	▶ 16060 MA	–
460		74	358	500	10,8	2 800	2 400	44	▶ 6060 M	–
540		85	462	670	13,7	2 400	2 000	88,5	6260 M	–
320	400	38	172	255	5,7	3 000	1 900	9,5	61864	–
	400	38	172	255	5,7	3 000	2 400	11	▶ 61864 MA	–
	440	56	276	400	8,65	2 800	2 400	25,5	▶ 61964 MA	–
	480	50	281	405	8,65	2 600	2 200	34	▶ 16064 MA	–
340	480	74	371	540	11,4	2 600	2 200	46	▶ 6064 M	–
	420	38	178	275	6	2 800	1 800	10	61868	–
	420	38	178	275	6	2 800	2 400	11,5	▶ 61868 MA	–
	460	56	281	425	9	2 600	2 200	26,5	▶ 61968 MA	–
	520	57	345	520	10,6	2 400	2 000	45	16068 MA	–
360	520	82	423	640	13,2	2 400	2 200	62	▶ 6068 M	–
	440	38	182	285	6,1	2 600	2 200	12	▶ 61872 MA	–
	480	56	291	450	9,15	2 600	2 200	28	▶ 61972 MA	–
	540	57	351	550	11	1 800	1 400	49	16072 MA	–
	540	82	442	695	14	2 400	1 900	64,5	▶ 6072 M	–
	380	480	46	242	390	8	2 400	2 000	20	▶ 61876 MA
520		65	338	540	10,8	2 400	1 900	40	▶ 61976 MA	–
560		57	377	620	12,2	2 200	1 400	51	16076 MA	–
560		82	436	695	13,7	2 200	1 800	70,5	▶ 6076 M	–

▶ Popular item

¹⁾ For bearings with only one shield or one non-contact seal (Z, RZ) the limiting speeds of the open bearings are valid.

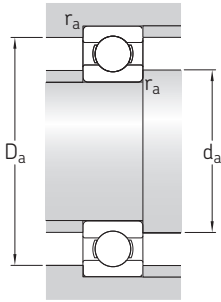

Dimensions						Abutment and fillet dimensions				Calculation factors		
d	d ₁ ≈	d ₂ ≈	D ₁ ≈	D ₂ ≈	r _{1,2} min.	d _a min.	d _a max.	D _a max.	r _a max.	k _r	f ₀	
mm						mm				–		
280	302	–	327	–	2	289	–	341	2	0,015	17	
	302	–	328	–	3,8	289	–	341	2	0,015	17	
	311	–	349	–	2,1	291	–	369	2	0,02	17	
	311	–	350	–	2,1	291	–	369	2	0,02	17	
	327	–	371	–	3	293	–	407	2,5	0,02	17	
	327	–	374	–	3	293	–	407	2,5	0,02	17	
	324	–	376	–	4	296	–	404	3	0,025	16	
	324	–	376	–	4	296	–	404	3	0,025	16	
	355	–	425	–	5	300	–	480	4	0,025	15	
	300	325	–	355	–	2,1	309	–	371	2	0,015	17
325		–	356	–	2,1	309	–	371	2	0,015	17	
338		–	382	–	3	313	–	407	2,5	0,02	16	
338		–	384	–	3	313	–	407	2,5	0,02	16	
352		–	407	–	4	315	–	445	3	0,02	16	
351		–	409	–	4	315	–	445	3	0,025	16	
383		–	457	–	5	320	–	520	4	0,025	15	
320		345	–	375	–	2,1	332	–	388	2	0,015	17
		345	–	376	–	2,1	332	–	388	2	0,015	17
		357	–	403	–	3	333	–	427	2,5	0,02	16
	372	–	428	–	4	335	–	465	3	0,02	17	
	370	–	431	–	4	335	–	465	3	0,025	16	
	340	365	–	395	–	2,1	352	–	408	2	0,015	17
365		–	396	–	2,1	352	–	408	2	0,015	17	
378		–	422	–	3	353	–	447	2,5	0,02	17	
398		–	462	–	4	355	–	505	3	0,02	16	
397		–	463	–	5	360	–	500	4	0,025	16	
360		385	–	415	–	2,1	372	–	428	2	0,015	17
	398	–	443	–	3	373	–	467	2,5	0,02	17	
	418	–	482	–	4	375	–	525	3	0,02	16	
	416	–	485	–	5	378	–	522	4	0,025	16	
	380	412	–	449	–	2,1	392	–	468	2	0,015	17
425		–	476	–	4	395	–	505	3	0,02	17	
443		–	497	–	4	395	–	545	3	0,02	17	
437		–	503	–	5	400	–	542	4	0,025	16	

1.1 Single row deep groove ball bearings

d 400 – 710 mm

1.1

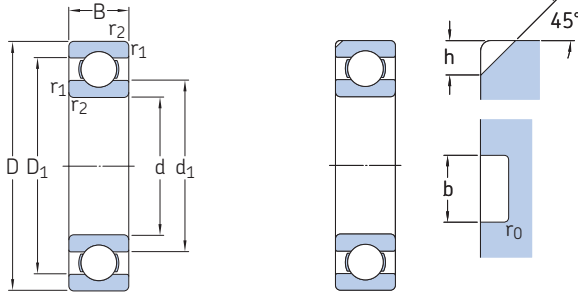

Designation	Dimensions		
	h	b	r ₀
–	mm		
60/500 N1MAS	20	15.5	3
60/530 N1MAS	20	15.5	3
60/560 N1MAS	25	20.5	3
619/630 N1MAS	25	20.5	3
60/630 N1MBS	32	20.5	3
60/670 N1MAS	32	20.5	3

Principal dimensions			Basic load ratings		Fatigue load limit	Speed ratings		Mass	Designations	
d	D	B	C	C ₀		Reference speed	Limiting speed ¹⁾		Bearing open or capped on both sides	capped on one side ¹⁾
mm			kN		kN	r/min	kg	–		
400	500	46	247	405	8,15	2 400	1 900	20,5	▶ 61880 MA	–
	540	65	345	570	11,2	2 200	1 800	41,5	▶ 61980 MA	–
	600	90	520	865	16,3	2 000	1 700	87,5	▶ 6080 M	–
420	520	46	251	425	8,3	2 200	1 800	21,5	▶ 61884 MA	–
	560	65	351	600	11,4	2 200	1 800	43	▶ 61984 MA	–
	620	90	507	880	16,3	2 000	1 600	91,5	6084 M	–
440	540	46	255	440	8,5	2 200	1 800	22,5	▶ 61888 MA	–
	600	74	410	720	13,2	2 000	1 600	60,5	61988 MA	–
	650	94	553	965	17,6	1 900	1 500	105	6088 M	–
460	580	56	319	570	10,6	2 000	1 600	35	▶ 61892 MA	–
	620	74	423	750	13,7	1 900	1 600	62,5	61992 MA	–
	680	100	582	1 060	19	1 800	1 500	120	6092 MB	–
480	600	56	325	600	10,8	1 900	1 600	36,5	▶ 61896 MA	–
	650	78	449	815	14,6	1 800	1 500	74	61996 MA	–
	700	100	618	1 140	20	1 700	1 400	125	6096 MB	–
500	620	56	332	620	11,2	1 800	1 500	40,5	▶ 618/500 MA	–
	670	78	462	865	15	1 700	1 400	81,5	619/500 MA	–
	720	100	605	1 140	19,6	1 600	1 300	135	60/500 N1MAS	–
530	650	56	332	655	11,2	1 700	1 400	39,5	▶ 618/530 MA	–
	710	82	488	930	15,6	1 600	1 300	90,5	619/530 MA	–
	780	112	650	1 270	20,8	1 500	1 200	185	60/530 N1MAS	–
560	680	56	345	695	11,8	1 600	1 300	42	▶ 618/560 MA	–
	750	85	494	980	16,3	1 500	1 200	105	619/560 MA	–
	820	115	663	1 370	22	1 400	1 200	210	60/560 N1MAS	–
600	730	60	364	765	12,5	1 500	1 200	52	▶ 618/600 MA	–
	800	90	585	1 220	19,6	1 400	1 100	125	619/600 MA	–
	870	118	728	1 500	23,6	1 300	1 100	230	60/600 MA	–
630	780	69	442	965	15,3	1 400	1 100	73	▶ 618/630 MA	–
	850	100	624	1 340	21,2	1 300	1 100	160	619/630 N1MA	–
	920	128	819	1 760	27	1 200	1 000	285	60/630 N1MBS	–
670	820	69	442	1 000	15,6	1 300	1 100	83,5	▶ 618/670 MA	–
	900	103	676	1 500	22,4	1 200	1 000	192	619/670 MA	–
	980	136	904	2 040	30	1 100	900	345	60/670 N1MAS	–
710	870	74	475	1 100	16,6	1 200	1 000	93,5	▶ 618/710 MA	–
	950	106	663	1 500	22	1 100	900	220	619/710 MA	–
	1 030	140	956	2 200	31,5	1 000	850	382	60/710 MA	–

▶ Popular item

¹⁾ For bearings with only one shield or one non-contact seal (Z, RZ) the limiting speeds of the open bearings are valid.

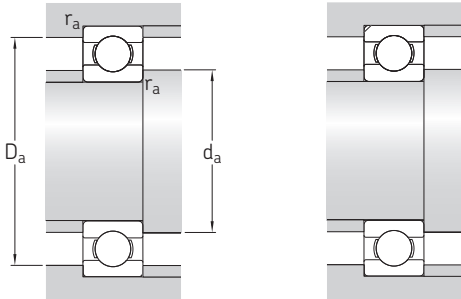

Dimensions						Abutment and fillet dimensions				Calculation factors	
d	d ₁ ≈	d ₂ ≈	D ₁ ≈	D ₂ ≈	r _{1,2} min.	d _a min.	d _a max.	D _a max.	r _a max.	k _r	f ₀
mm						mm				–	
400	432	–	471	–	2,1	412	–	488	2	0,015	17
	445	–	496	–	4	415	–	525	3	0,02	17
	463	–	537	–	5	418	–	582	4	0,025	16
420	452	–	491	–	2,1	432	–	508	2	0,015	17
	465	–	516	–	4	435	–	545	3	0,02	17
	482	–	557	–	5	438	–	602	4	0,025	16
440	472	–	510	–	2,1	452	–	528	2	0,015	17
	492	–	549	–	4	455	–	585	3	0,02	17
	506	–	584	–	6	463	–	627	5	0,025	16
460	498	–	542	–	3	473	–	567	2,5	0,015	17
	511	–	569	–	4	476	–	604	3	0,02	17
	528	–	614	–	6	483	–	657	5	0,025	16
480	518	–	564	–	3	493	–	587	2,5	0,015	17
	535	–	595	–	5	498	–	632	4	0,02	17
	550	–	630	–	6	503	–	677	5	0,025	16
500	538	–	582	–	3	513	–	607	2,5	0,015	17
	555	–	617	–	5	518	–	652	4	0,02	17
	568	–	650	–	6	523	–	697	5	0,025	16
530	568	–	613	–	3	543	–	637	2,5	0,015	17
	587	–	653	–	5	548	–	692	4	0,02	17
	612	–	700	–	6	553	–	757	5	0,025	16
560	598	–	644	–	3	573	–	667	2,5	0,015	17
	622	–	689	–	5	578	–	732	4	0,02	17
	648	–	732	–	6	583	–	797	5	0,025	16
600	642	–	688	–	3	613	–	717	2,5	0,015	17
	663	–	736	–	5	618	–	782	4	0,02	17
	689	–	781	–	6	623	–	847	5	0,025	16
630	678	–	732	–	4	645	–	765	3	0,015	17
	702	–	778	–	6	653	–	827	5	0,02	17
	725	–	825	–	7,5	658	–	892	6	0,025	16
670	718	–	772	–	4	685	–	805	3	0,015	17
	745	–	825	–	6	693	–	877	5	0,02	17
	771	–	878	–	7,5	698	–	952	6	0,025	16
710	761	–	818	–	4	725	–	855	3	0,015	17
	790	–	870	–	6	733	–	927	5	0,02	17
	811	–	928	–	7,5	738	–	1 002	6	0,025	16

1.1 Single row deep groove ball bearings

d 750 – 1 500 mm

1.1

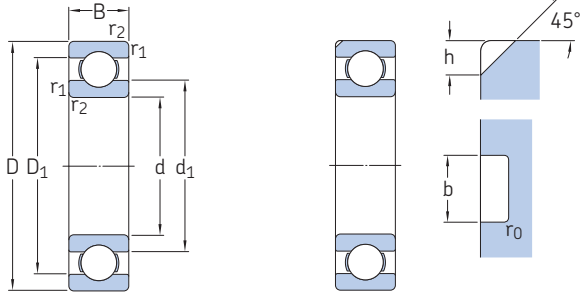

Designation	Dimensions		
	h	b	r ₀
–	mm		
60/800 N1MAS	32	20.5	3

Principal dimensions			Basic load ratings		Fatigue load limit	Speed ratings		Mass	Designations	
d	D	B	dynamic	static		Reference speed	Limiting speed ¹⁾		Bearing open or capped on both sides	capped on one side ¹⁾
mm			kN		kN	r/min	kg	–		
750	920	78	527	1 250	18,3	1 100	900	110	▶ 618/750 MA	–
	1 000	112	761	1 800	25,5	1 000	850	255	619/750 MA	–
	1 090	150	995	2 360	33,5	950	800	485	60/750 MA	–
800	980	82	559	1 370	19,3	1 000	850	130	▶ 618/800 MA	–
	1 060	115	832	2 040	28,5	950	800	275	619/800 MA	–
	1 150	155	1 010	2 550	34,5	900	750	523	60/800 N1MAS	–
850	1 030	82	559	1 430	19,6	950	750	140	▶ 618/850 MA	–
	1 120	118	852	2 120	28,5	850	750	320	619/850 MA	–
900	1 090	85	618	1 600	21,6	850	700	167	▶ 618/900 MA	–
950	1 150	90	637	1 730	22,4	800	670	197	▶ 618/950 MA	–
1 000	1 220	100	637	1 800	22,8	750	600	245	▶ 618/1000 MA	–
1 060	1 280	100	728	2 120	26,5	670	560	260	618/1060 MA	–
1 120	1 360	106	741	2 200	26,5	630	530	315	▶ 618/1120 MA	–
1 180	1 420	106	761	2 360	27,5	560	480	337	618/1180 MB	–
1 320	1 600	122	956	3 150	35,5	480	400	500	618/1320 MA	–
1 500	1 820	140	1 170	4 150	43	380	240	638	618/1500 TN	–

▶ Popular item

¹⁾ For bearings with only one shield or one non-contact seal (Z, RZ) the limiting speeds of the open bearings are valid.

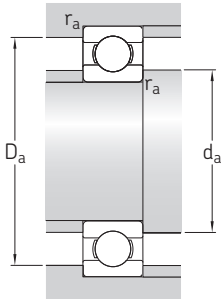

Dimensions						Abutment and fillet dimensions				Calculation factors	
d	d ₁ ≈	d ₂ ≈	D ₁ ≈	D ₂ ≈	r _{1,2} min.	d _a min.	d _a max.	D _a max.	r _a max.	k _r	f ₀
mm						mm				–	
750	804	–	866	–	5	768	–	902	4	0,015	17
	835	–	919	–	6	773	–	977	5	0,02	17
	862	–	978	–	7,5	778	–	1 062	6	0,025	16
800	857	–	922	–	5	818	–	962	4	0,015	17
	884	–	975	–	6	823	–	1 037	5	0,02	17
	914	–	1 032	–	7,5	828	–	1 122	6	0,025	16
850	907	–	972	–	5	868	–	1 012	4	0,015	17
	937	–	1 033	–	6	873	–	1 097	5	0,02	17
900	960	–	1 029	–	5	918	–	1 072	4	0,015	18
950	1 015	–	1 084	–	5	968	–	1 132	4	0,015	18
1 000	1 076	–	1 145	–	6	1 023	–	1 197	5	0,015	17
1 060	1 132	–	1 208	–	6	1 083	–	1 257	5	0,015	18
1 120	1 201	–	1 278	–	6	1 143	–	1 337	5	0,015	18
1 180	1 262	–	1 338	–	6	1 203	–	1 397	5	0,015	18
1 320	1 414	–	1 506	–	6	1 343	–	1 577	5	0,015	18
1 500	1 606	–	1 712	–	7,5	1 528	–	1 792	6	0,015	18

1.2 ICOS oil sealed bearing units

d 12 – 30 mm

1.2

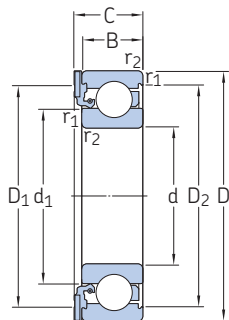

Principal dimensions				Basic load ratings		Fatigue load limit	Limiting speed	Mass	Designation
d	D	B	C	dynamic	static				
mm				C	C ₀	P _u	r/min	kg	–
12	32	10	12,6	7,28	3,1	0,132	14 000	0,041	ICOS-D1B01 TN9
15	35	11	13,2	8,06	3,75	0,16	12 000	0,048	ICOS-D1B02 TN9
17	40	12	14,2	9,95	4,75	0,2	11 000	0,071	ICOS-D1B03 TN9
20	47	14	16,2	13,5	6,55	0,28	9 300	0,11	ICOS-D1B04 TN9
25	52	15	17,2	14,8	7,8	0,335	7 700	0,14	ICOS-D1B05 TN9
30	62	16	19,4	20,3	11,2	0,475	6 500	0,22	ICOS-D1B06 TN9

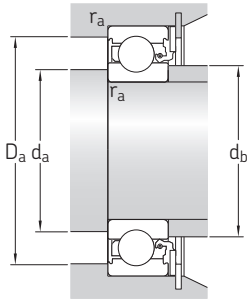

Dimensions					Abutment and fillet dimensions					Calculation factors	
d	d_1 ≈	D_1 ≈	D_2 ≈	$r_{1,2}$ min.	d_a, d_b min.	d_a max.	d_b max.	D_a max.	r_a max.	k_r	f_0
mm					mm					-	
12	18,4	-1)	27,4	0,6	16,2	18,4	18	27,8	0,6	0,025	12
15	21,7	30,8	30,5	0,6	19,2	21,7	21,5	30,8	0,6	0,025	13
17	24,5	35,6	35	0,6	21,2	24,5	24	35,8	0,6	0,025	13
20	28,8	42	40,6	1	25,6	28,8	28,5	41,4	1	0,025	13
25	34,3	47	46,3	1	30,6	34,3	34	46,4	1	0,025	14
30	40,3	55,6	54,1	1	35,6	40,3	40	56	1	0,025	14

¹⁾ Full rubber cross section

1.3 Single row deep groove ball bearings with a snap ring groove

d 10 – 35 mm

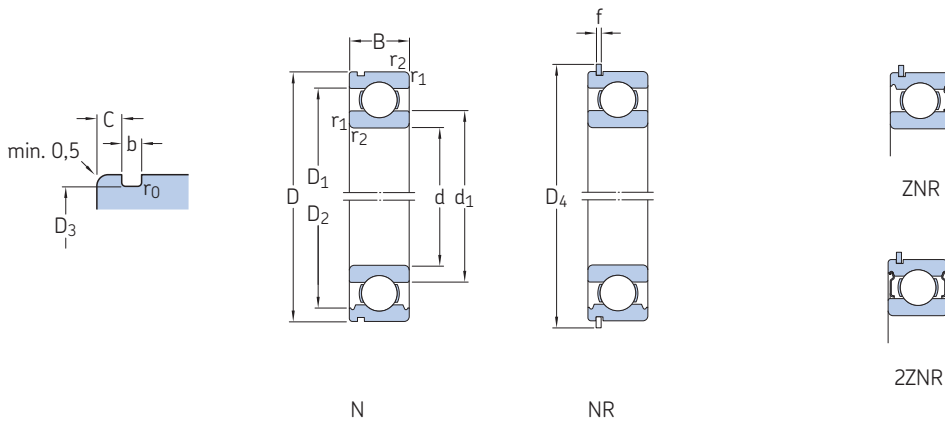

Principal dimensions			Basic load ratings		Fatigue load limit	Speed ratings		Mass	Designations		Snap ring
d	D	B	C	C ₀	P _u	Reference speed	Limiting speed ¹⁾		Bearings ¹⁾		
mm			kN		kN	r/min		kg	–		
10	30	9	5,4	2,36	0,1	56 000	28 000	0,035	6200-ZNR	6200-2ZNR	SP 30
	30	9	5,4	2,36	0,1	56 000	36 000	0,032	6200 N	6200 NR	SP 30
12	32	10	7,28	3,1	0,132	50 000	26 000	0,037	6201-ZNR	6201-2ZNR	SP 32
	32	10	7,28	3,1	0,132	50 000	32 000	0,037	6201 N	6201 NR	SP 32
15	35	11	8,06	3,75	0,16	43 000	22 000	0,045	6202-ZNR	6202-2ZNR	SP 35
	35	11	8,06	3,75	0,16	43 000	28 000	0,045	6202 N	6202 NR	SP 35
17	40	12	9,95	4,75	0,2	38 000	19 000	0,065	6203-ZNR	6203-2ZNR	SP 40
	40	12	9,95	4,75	0,2	38 000	24 000	0,065	6203 N	6203 NR	SP 40
	47	14	14,3	6,55	0,275	34 000	17 000	0,12	6303-ZNR	6303-2ZNR	SP 47
	47	14	14,3	6,55	0,275	34 000	22 000	0,12	6303 N	6303 NR	SP 47
20	42	12	9,95	5	0,212	38 000	19 000	0,069	6004-ZNR	6004-2ZNR	SP 42
	42	12	9,95	5	0,212	38 000	24 000	0,069	6004 N	6004 NR	SP 42
	47	14	13,5	6,55	0,28	32 000	17 000	0,11	6204-ZNR	6204-2ZNR	SP 47
	47	14	13,5	6,55	0,28	32 000	20 000	0,11	6204 N	6204 NR	SP 47
	52	15	16,8	7,8	0,335	30 000	15 000	0,16	6304-ZNR	6304-2ZNR	SP 52
52	15	16,8	7,8	0,335	30 000	19 000	0,15	6304 N	6304 NR	SP 52	
25	47	12	11,9	6,55	0,275	32 000	16 000	0,08	6005-ZNR	6005-2ZNR	SP 47
	47	12	11,9	6,55	0,275	32 000	20 000	0,08	6005 N	6005 NR	SP 47
	52	15	14,8	7,8	0,335	28 000	14 000	0,13	6205-ZNR	6205-2ZNR	SP 52
	52	15	14,8	7,8	0,335	28 000	18 000	0,13	6205 N	6205 NR	SP 52
	62	17	23,4	11,6	0,49	24 000	13 000	0,24	6305-ZNR	6305-2ZNR	SP 62
62	17	23,4	11,6	0,49	24 000	16 000	0,23	6305 N	6305 NR	SP 62	
30	55	13	13,8	8,3	0,355	28 000	17 000	0,12	6006 N	6006 NR	SP 55
	62	16	20,3	11,2	0,475	24 000	12 000	0,21	6206-ZNR	6206-2ZNR	SP 62
	62	16	20,3	11,2	0,475	24 000	15 000	0,21	6206 N	6206 NR	SP 62
	72	19	29,6	16	0,67	20 000	11 000	0,37	6306-ZNR	6306-2ZNR	SP 72
72	19	29,6	16	0,67	20 000	13 000	0,36	6306 N	6306 NR	SP 72	
35	62	14	16,8	10,2	0,44	24 000	15 000	0,16	6007 N	6007 NR	SP 62
	72	17	27	15,3	0,655	20 000	10 000	0,31	6207-ZNR	6207-2ZNR	SP 72
	72	17	27	15,3	0,655	20 000	13 000	0,3	6207 N	6207 NR	SP 72
80	80	21	35,1	19	0,82	19 000	9 500	0,48	6307-ZNR	6307-2ZNR	SP 80
	80	21	35,1	19	0,82	19 000	12 000	0,47	6307 N	6307 NR	SP 80
	100	25	55,3	31	1,29	16 000	10 000	0,99	6407 N	6407 NR	SP 100

SKF Explorer bearing

¹⁾ For bearings with one shield (ZNR) the limiting speeds of the open bearings are valid.

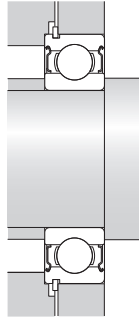
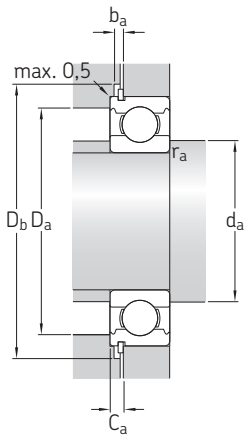

Dimensions										Abutment and fillet dimensions								Calculation factors		
d	d ₁	D ₁	D ₂	D ₃	D ₄	b	f	C	r _{1,2} min.	r ₀ max.	d _a min.	d _a max.	D _a max.	D _b min.	b _a min.	C _a max.	r _a max.	k _r	f ₀	
mm											mm								-	
10	17	-	24,8	28,17	34,7	1,35	1,12	2,06	0,6	0,4	14,2	16,9	25,8	36	1,5	3,18	0,6	0,025	13	
	17	-	24,8	28,17	34,7	1,35	1,12	2,06	0,6	0,4	14,2	-	25,8	36	1,5	3,18	0,6	0,025	13	
12	18,4	-	27,4	30,15	36,7	1,35	1,12	2,06	0,6	0,4	16,2	18,4	27,8	38	1,5	3,18	0,6	0,025	12	
	18,4	-	27,4	30,15	36,7	1,35	1,12	2,06	0,6	0,4	16,2	-	27,8	38	1,5	3,18	0,6	0,025	12	
15	21,7	-	30,5	33,17	39,7	1,35	1,12	2,06	0,6	0,4	19,2	21,6	30,8	41	1,5	3,18	0,6	0,025	13	
	21,7	-	30,5	33,17	39,7	1,35	1,12	2,06	0,6	0,4	19,2	-	30,8	41	1,5	3,18	0,6	0,025	13	
17	24,5	-	35	38,1	44,6	1,35	1,12	2,06	0,6	0,4	21,2	24,4	35,8	46	1,5	3,18	0,6	0,025	13	
	24,5	-	35	38,1	44,6	1,35	1,12	2,06	0,6	0,4	21,2	-	35,8	46	1,5	3,18	0,6	0,025	13	
	26,5	-	39,6	44,6	52,7	1,35	1,12	2,46	1	0,4	22,6	26,4	41,4	54	1,5	3,58	1	0,03	12	
	26,5	-	39,6	44,6	52,7	1,35	1,12	2,46	1	0,4	22,6	-	41,4	54	1,5	3,58	1	0,03	12	
	26,5	-	39,6	44,6	52,7	1,35	1,12	2,46	1	0,4	22,6	-	41,4	54	1,5	3,58	1	0,03	12	
20	27,2	-	37,2	39,75	46,3	1,35	1,12	2,06	0,6	0,4	23,2	27,1	38,8	48	1,5	3,18	0,6	0,025	14	
	27,2	-	37,2	39,75	46,3	1,35	1,12	2,06	0,6	0,4	23,2	-	38,8	48	1,5	3,18	0,6	0,025	14	
	28,8	-	40,6	44,6	52,7	1,35	1,12	2,46	1	0,4	25,6	28,7	41,4	54	1,5	3,58	1	0,025	13	
	28,8	-	40,6	44,6	52,7	1,35	1,12	2,46	1	0,4	25,6	-	41,4	54	1,5	3,58	1	0,025	13	
	30,3	-	44,8	49,73	57,9	1,35	1,12	2,46	1,1	0,4	27	30,3	45	59	1,5	3,58	1	0,03	12	
30,3	-	44,8	49,73	57,9	1,35	1,12	2,46	1,1	0,4	27	-	45	59	1,5	3,58	1	0,03	12		
25	32	-	42,2	44,6	52,7	1,35	1,12	2,06	0,6	0,4	28,2	31,9	43,8	54	1,5	3,18	0,6	0,025	14	
	32	-	42,2	44,6	52,7	1,35	1,12	2,06	0,6	0,4	28,2	-	43,8	54	1,5	3,18	0,6	0,025	14	
	34,3	-	46,3	49,73	57,9	1,35	1,12	2,46	1	0,4	30,6	34,3	46,4	59	1,5	3,58	1	0,025	14	
	34,3	-	46,3	49,73	57,9	1,35	1,12	2,46	1	0,4	30,6	-	46,4	59	1,5	3,58	1	0,025	14	
	36,6	-	52,7	59,61	67,7	1,9	1,7	3,28	1,1	0,6	32	36,5	55	69	2,2	4,98	1	0,03	12	
36,6	-	52,7	59,61	67,7	1,9	1,7	3,28	1,1	0,6	32	-	55	69	2,2	4,98	1	0,03	12		
30	38,2	-	49	52,6	60,7	1,35	1,12	2,06	1	0,4	34,6	-	50	62	1,5	3,18	1	0,025	15	
	40,3	-	54,1	59,61	67,7	1,9	1,7	3,28	1	0,6	35,6	40,3	56	69	2,2	4,98	1	0,025	14	
	40,3	-	54,1	59,61	67,7	1,9	1,7	3,28	1	0,6	35,6	-	56	69	2,2	4,98	1	0,025	14	
	44,6	-	61,9	68,81	78,6	1,9	1,7	3,28	1,1	0,6	37	44,5	65	80	2,2	4,98	1	0,03	13	
	44,6	-	61,9	68,81	78,6	1,9	1,7	3,28	1,1	0,6	37	-	65	80	2,2	4,98	1	0,03	13	
35	43,7	-	55,7	59,61	67,7	1,9	1,7	2,06	1	0,6	39,6	-	57	69	2,2	3,76	1	0,025	15	
	46,9	-	62,7	68,81	78,6	1,9	1,7	3,28	1,1	0,6	42	46,8	65	80	2,2	4,98	1	0,025	14	
	46,9	-	62,7	68,81	78,6	1,9	1,7	3,28	1,1	0,6	42	-	65	80	2,2	4,98	1	0,025	14	
	49,5	-	69,2	76,81	86,6	1,9	1,7	3,28	1,5	0,6	44	49,5	71	88	2,2	4,98	1,5	0,03	13	
	49,5	-	69,2	76,81	86,6	1,9	1,7	3,28	1,5	0,6	44	-	71	88	2,2	4,98	1,5	0,03	13	
57,4	79,6	-	96,8	106,5	2,7	2,46	3,28	1,5	0,6	46	-	89	108	3	5,74	1,5	0,035	12		

1.3 Single row deep groove ball bearings with a snap ring groove

d 40 – 65 mm

1.3

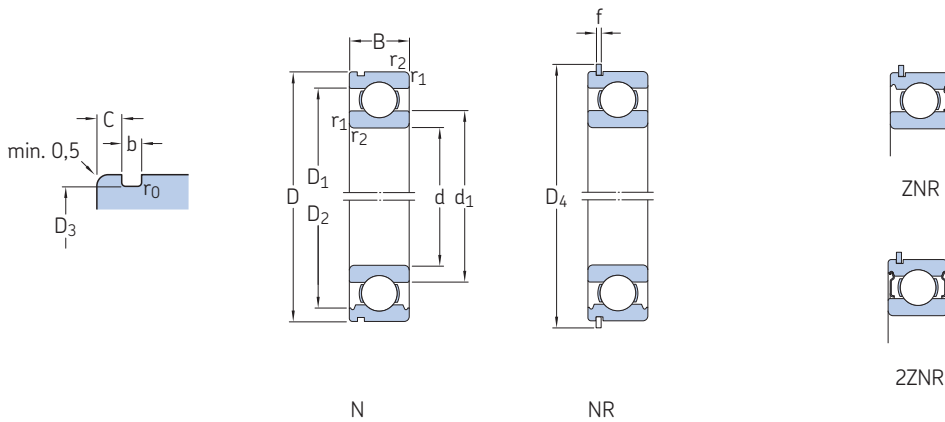

Principal dimensions			Basic load ratings		Fatigue load limit	Speed ratings		Mass	Designations	Snap ring	
d	D	B	C	C ₀	P _u	Reference speed	Limiting speed ¹⁾		Bearings ¹⁾		
mm			kN		kN	r/min		kg	–		
40	68	15	17,8	11	0,49	22 000	14 000	0,19	6008 N	6008 NR	SP 68
	80	18	32,5	19	0,8	18 000	9 000	0,39	6208-ZNR	6208-2ZNR	SP 80
	80	18	32,5	19	0,8	18 000	11 000	0,38	6208 N	6208 NR	SP 80
45	90	23	42,3	24	1,02	17 000	8 500	0,64	6308-ZNR	6308-2ZNR	SP 90
	90	23	42,3	24	1,02	17 000	11 000	0,64	6308 N	6308 NR	SP 90
	110	27	63,7	36,5	1,53	14 000	9 000	1,3	6408 N	6408 NR	SP 110
50	75	16	22,1	14,6	0,64	20 000	12 000	0,24	6009 N	6009 NR	SP 75
	85	19	35,1	21,6	0,915	17 000	8 500	0,44	6209-ZNR	6209-2ZNR	SP 85
	85	19	35,1	21,6	0,915	17 000	11 000	0,43	6209 N	6209 NR	SP 85
	100	25	55,3	31,5	1,34	15 000	7 500	0,89	6309-ZNR	6309-2ZNR	SP 100
	100	25	55,3	31,5	1,34	15 000	9 500	0,85	6309 N	6309 NR	SP 100
55	120	29	76,1	45	1,9	13 000	8 500	1,6	6409 N	6409 NR	SP 120
	80	16	22,9	15,6	0,71	18 000	11 000	0,27	6010 N	6010 NR	SP 80
	90	20	37,1	23,2	0,98	15 000	8 000	0,49	6210-ZNR	6210-2ZNR	SP 90
	90	20	37,1	23,2	0,98	15 000	10 000	0,47	6210 N	6210 NR	SP 90
	110	27	65	38	1,6	13 000	6 700	1,15	6310-ZNR	6310-2ZNR	SP 110
60	110	27	65	38	1,6	13 000	8 500	1,1	6310 N	6310 NR	SP 110
	130	31	87,1	52	2,2	12 000	7 500	2	6410 N	6410 NR	SP 130
	90	18	29,6	21,2	0,9	16 000	10 000	0,4	6011 N	6011 NR	SP 90
	100	21	46,2	29	1,25	14 000	7 000	0,66	6211-ZNR	6211-2ZNR	SP 100
	100	21	46,2	29	1,25	14 000	9 000	0,63	6211 N	6211 NR	SP 100
	120	29	74,1	45	1,9	12 000	6 300	1,45	6311-ZNR	6311-2ZNR	SP 120
	120	29	74,1	45	1,9	12 000	8 000	1,4	6311 N	6311 NR	SP 120
65	140	33	99,5	62	2,6	11 000	7 000	2,4	6411 N	6411 NR	SP 140
	95	18	30,7	23,2	0,98	15 000	9 500	0,43	6012 N	6012 NR	SP 95
	110	22	55,3	36	1,53	13 000	6 300	0,83	6212-ZNR	6212-2ZNR	SP 110
	110	22	55,3	36	1,53	13 000	8 000	0,8	6212 N	6212 NR	SP 110
	130	31	85,2	52	2,2	11 000	5 600	1,8	6312-ZNR	6312-2ZNR	SP 130
65	130	31	85,2	52	2,2	11 000	7 000	1,75	6312 N	6312 NR	SP 130
	150	35	108	69,5	2,9	10 000	6 300	2,9	6412 N	6412 NR	SP 150
	100	18	31,9	25	1,06	14 000	9 000	0,45	6013 N	6013 NR	SP 100
	120	23	58,5	40,5	1,73	12 000	6 000	1,1	6213-ZNR	6213-2ZNR	SP 120
	120	23	58,5	40,5	1,73	12 000	7 500	1,05	6213 N	6213 NR	SP 120
65	140	33	97,5	60	2,5	10 000	5 300	2,25	6313-ZNR	6313-2ZNR	SP 140
	140	33	97,5	60	2,5	10 000	6 700	2,15	6313 N	6313 NR	SP 140
	160	37	119	78	3,15	9 500	6 000	3,4	6413 N	6413 NR	SP 160

SKF Explorer bearing

¹⁾ For bearings with one shield (ZNR) the limiting speeds of the open bearings are valid.

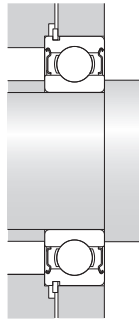
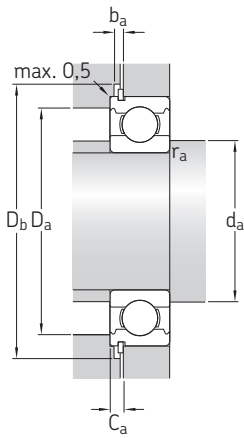

Dimensions										Abutment and fillet dimensions								Calculation factors	
d	d ₁	D ₁	D ₂	D ₃	D ₄	b	f	C	r _{1,2}	r ₀	d _a	d _a	D _a	D _b	b _a	C _a	r _a	k _r	f ₀
mm										mm								-	
40	49,2	-	61,1	64,82	74,6	1,9	1,7	2,49	1	0,6	44,6	-	63	76	2,2	4,19	1	0,025	15
	52,6	-	69,8	76,81	86,6	1,9	1,7	3,28	1,1	0,6	47	52	73	88	2,2	4,98	1	0,025	14
	52,6	-	69,8	76,81	86,6	1,9	1,7	3,28	1,1	0,6	47	-	73	88	2,2	4,98	1	0,025	14
45	56,1	-	77,7	86,79	96,5	2,7	2,46	3,28	1,5	0,6	49	56	81	98	3	5,74	1,5	0,03	13
	56,1	-	77,7	86,79	96,5	2,7	2,46	3,28	1,5	0,6	49	-	81	98	3	5,74	1,5	0,03	13
	62,8	87	-	106,81	116,6	2,7	2,46	3,28	2	0,6	53	-	97	118	3	5,74	2	0,035	12
45	54,7	-	67,8	71,83	81,6	1,9	1,7	2,49	1	0,6	51	-	69	83	2,2	4,19	1	0,025	15
	57,6	-	75,2	81,81	91,6	1,9	1,7	3,28	1,1	0,6	52	57	78	93	2,2	4,98	1	0,025	14
	57,6	-	75,2	81,81	91,6	1,9	1,7	3,28	1,1	0,6	52	-	78	93	2,2	4,98	1	0,025	14
50	62,1	-	86,7	96,8	106,5	2,7	2,46	3,28	1,5	0,6	54	62	91	108	3	5,74	1,5	0,03	13
	62,1	-	86,7	96,8	106,5	2,7	2,46	3,28	1,5	0,6	54	-	91	108	3	5,74	1,5	0,03	13
	68,9	95,9	-	115	129,7	3,1	2,82	4,06	2	0,6	58	-	107	131	3,5	6,88	2	0,035	12
50	59,7	-	72,8	76,81	86,6	1,9	1,7	2,49	1	0,6	55	-	75	88	2,2	4,19	1	0,025	15
	62,5	-	81,7	86,79	96,5	2,7	2,46	3,28	1,1	0,6	57	62	83	98	3	5,74	1	0,025	14
	62,5	-	81,7	86,79	96,5	2,7	2,46	3,28	1,1	0,6	57	-	83	98	3	5,74	1	0,025	14
55	68,7	-	95,2	106,81	116,6	2,7	2,46	3,28	2	0,6	61	68	99	118	3	5,74	2	0,03	13
	68,7	-	95,2	106,81	116,6	2,7	2,46	3,28	2	0,6	61	-	99	118	3	5,74	2	0,03	13
	75,4	105	-	125,22	139,7	3,1	2,82	4,06	2,1	0,6	64	-	116	141	3,5	6,88	2	0,035	12
55	66,3	-	81,5	86,79	96,5	2,7	2,46	2,87	1,1	0,6	61	-	84	98	3	5,33	1	0,025	15
	69	-	89,4	96,8	106,5	2,7	2,46	3,28	1,5	0,6	64	69	91	108	3	5,74	1,5	0,025	14
	69	-	89,4	96,8	106,5	2,7	2,46	3,28	1,5	0,6	64	-	91	108	3	5,74	1,5	0,025	14
60	71,3	-	86,5	91,82	101,6	2,7	2,46	2,87	1,1	0,6	66	-	89	103	3	5,33	1	0,025	16
	75,5	-	98	106,81	116,6	2,7	2,46	3,28	1,5	0,6	69	75	101	118	3	5,74	1,5	0,025	14
	75,5	-	98	106,81	116,6	2,7	2,46	3,28	1,5	0,6	69	-	101	118	3	5,74	1,5	0,025	14
65	81,8	-	113	125,22	139,7	3,1	2,82	4,06	2,1	0,6	72	81	118	141	3,5	6,88	2	0,03	13
	81,8	-	113	125,22	139,7	3,1	2,82	4,06	2,1	0,6	72	-	118	141	3,5	6,88	2	0,03	13
	88,1	122	-	145,24	159,7	3,1	2,82	4,9	2,1	0,6	74	-	136	162	3,5	7,72	2	0,035	12
65	76,3	-	91,5	96,8	106,5	2,7	2,46	2,87	1,1	0,6	71	-	94	108	3	5,33	1	0,025	16
	83,3	-	106	115,21	129,7	3,1	2,82	4,06	1,5	0,6	74	83	111	131	3,5	6,88	1,5	0,025	15
	83,3	-	106	115,21	129,7	3,1	2,82	4,06	1,5	0,6	74	-	111	131	3,5	6,88	1,5	0,025	15
65	88,3	-	122	135,23	149,7	3,1	2,82	4,9	2,1	0,6	77	88	128	151	3,5	7,72	2	0,03	13
	88,3	-	122	135,23	149,7	3,1	2,82	4,9	2,1	0,6	77	-	128	151	3,5	7,72	2	0,03	13
	94	131	-	155,22	169,7	3,1	2,82	4,9	2,1	0,6	79	-	146	172	3,5	7,72	2	0,035	12

1.3 Single row deep groove ball bearings with a snap ring groove d 70 – 120 mm

1.3

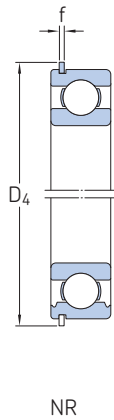
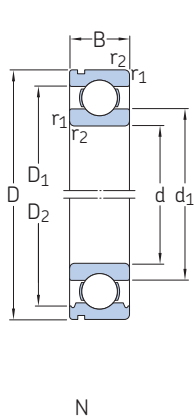

ZNR



2ZNR

Principal dimensions			Basic load ratings		Fatigue load limit	Speed ratings		Mass	Designations Bearings ¹⁾	Snap ring	
d	D	B	C	C ₀		Reference speed	Limiting speed ¹⁾				
mm			kN		kN	r/min	kg	–			
70	110	20	39,7	31	1,32	13 000	8 000	0,63	6014 N	6014 NR	SP110
	125	24	63,7	45	1,9	11 000	5 600	1,15	6214-ZNR	6214-2ZNR	SP125
	125	24	63,7	45	1,9	11 000	7 000	1,15	6214 N	6214 NR	SP125
150	150	35	111	68	2,75	9 500	5 000	2,65	6314-ZNR	6314-2ZNR	SP150
	150	35	111	68	2,75	9 500	6 300	2,6	6314 N	6314 NR	SP150
75	115	20	41,6	33,5	1,43	12 000	7 500	0,67	6015 N	6015 NR	SP115
	130	25	68,9	49	2,04	10 000	6 700	1,25	6215 N	6215 NR	SP130
	160	37	119	76,5	3	9 000	5 600	3,05	6315 N	6315 NR	SP160
80	125	22	49,4	40	1,66	11 000	7 000	0,92	6016 N	6016 NR	SP125
	140	26	72,8	55	2,2	9 500	6 000	1,5	6216 N	6216 NR	SP140
85	130	22	52	43	1,76	11 000	6 700	0,94	6017 N	6017 NR	SP130
	150	28	87,1	64	2,5	9 000	5 600	1,85	6217 N	6217 NR	SP150
90	140	24	60,5	50	1,96	10 000	6 300	1,2	6018 N	6018 NR	SP140
	160	30	101	73,5	2,8	8 500	5 300	2,25	6218 N	6218 NR	SP160
95	170	32	114	81,5	3	8 000	5 000	2,7	6219 N	6219 NR	SP170
100	150	24	63,7	54	2,04	9 500	5 600	1,3	6020 N	6020 NR	SP150
	180	34	127	93	3,35	7 500	4 800	3,25	6220 N	6220 NR	SP180
105	160	26	76,1	65,5	2,4	8 500	5 300	1,65	6021 N	6021 NR	SP160
110	170	28	85,2	73,5	2,6	8 000	5 000	2,05	6022 N	6022 NR	SP170
120	180	28	88,4	80	2,75	7 500	4 800	2,2	6024 N	6024 NR	SP180

SKF Explorer bearing

¹⁾ For bearings with one shield (ZNR) the limiting speeds of the open bearings are valid.

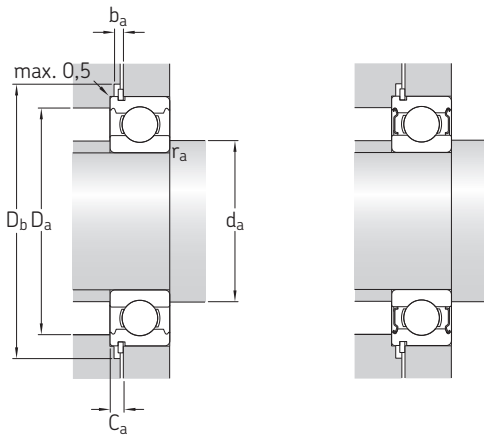

Dimensions										Abutment and fillet dimensions								Calculation factors	
d	d ₁	D ₁	D ₂	D ₃	D ₄	b	f	C	r _{1,2} min.	r ₀ max.	d _a min.	d _a max.	D _a max.	D _b min.	b _a min.	C _a max.	r _a max.	k _r	f ₀
mm										mm								-	
70	82,8	-	99,9	106,81	116,6	2,7	2,46	2,87	1,1	0,6	76	-	104	118	3	5,33	1	0,025	16
	87	-	111	120,22	134,7	3,1	2,82	4,06	1,5	0,6	79	87	116	136	3,5	6,88	1,5	0,025	15
	87	-	111	120,22	134,7	3,1	2,82	4,06	1,5	0,6	79	-	116	136	3,5	6,88	1,5	0,025	15
	94,9	-	130	145,25	159,7	3,1	2,82	4,9	2,1	0,6	82	94	138	162	3,5	7,72	2	0,03	13
	94,9	-	130	145,25	159,7	3,1	2,82	4,9	2,1	0,6	82	-	138	162	3,5	7,72	2	0,03	13
75	87,8	-	105	111,81	121,6	2,7	2,46	2,87	1,1	0,6	81	-	109	123	3	5,33	1	0,025	16
	92	-	117	125,22	139,7	3,1	2,82	4,06	1,5	0,6	84	-	121	141	3,5	6,88	1,5	0,025	15
	101	-	139	155,22	169,7	3,1	2,82	4,9	2,1	0,6	87	-	148	172	3,5	7,72	2	0,03	13
80	94,4	-	115	120,22	134,7	3,1	2,82	2,87	1,1	0,6	86	-	119	136	3,5	5,69	1	0,025	16
	101	-	127	135,23	149,7	3,1	2,82	4,9	2	0,6	91	-	129	151	3,5	7,72	2	0,025	15
85	99,4	-	120	125,22	139,7	3,1	2,82	2,87	1,1	0,6	92	-	123	141	3,5	5,69	1	0,025	16
	106	-	135	145,24	159,7	3,1	2,82	4,9	2	0,6	96	-	139	162	3,5	7,72	2	0,025	15
90	105	-	129	135,23	149,7	3,1	2,82	3,71	1,5	0,6	97	-	133	151	3,5	6,53	1,5	0,025	16
	112	-	143	155,22	169,7	3,1	2,82	4,9	2	0,6	101	-	149	172	3,5	7,72	2	0,025	15
95	118	-	152	163,65	182,9	3,5	3,1	5,69	2,1	0,6	107	-	158	185	4	8,79	2	0,025	14
100	115	-	139	145,24	159,7	3,1	2,82	3,71	1,5	0,6	107	-	143	162	3,5	6,53	1,5	0,025	16
	124	-	160	173,66	192,9	3,5	3,1	5,69	2,1	0,6	112	-	168	195	4	8,79	2	0,025	14
105	122	-	147	155,22	169,7	3,1	2,82	3,71	2	0,6	116	-	149	172	3,5	6,53	2	0,025	16
110	129	-	156	163,65	182,9	3,5	3,1	3,71	2	0,6	119	-	161	185	4	6,81	2	0,025	16
120	139	-	166	173,66	192,9	3,5	3,1	3,71	2	0,6	129	-	171	195	4	6,81	2	0,025	16

1.4 Stainless steel deep groove ball bearings

d 1 – 5 mm

1.4

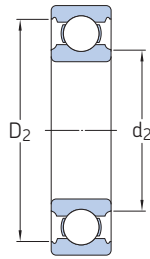
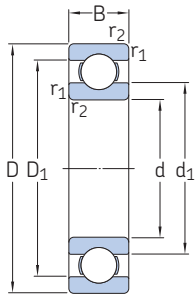

2Z



2Z



2RS1

Principal dimensions			Basic load ratings		Fatigue load limit	Speed ratings		Mass	Designation
d	D	B	C	C ₀	P _u	Reference speed	Limiting speed		
mm			kN		kN	r/min		g	–
1	3	1	0,052	0,012	0,001	240 000	150 000	0,03	W 618/1
1,5	4	1,2	0,062	0,016	0,001	220 000	140 000	0,1	W 618/1.5
	4	2	0,062	0,016	0,001	220 000	110 000	0,1	W 638/1.5-2Z
2	5	1,5	0,094	0,025	0,001	200 000	120 000	0,1	W 618/2
	5	2,3	0,094	0,025	0,001	200 000	100 000	0,2	▶ W 638/2-2Z
	6	3	0,19	0,051	0,002	180 000	90 000	0,31	W 639/2-2Z
2,5	6	2,6	0,117	0,036	0,002	170 000	85 000	0,31	▶ W 638/2.5-2Z
3	6	3	0,117	0,036	0,002	170 000	85 000	0,31	▶ W 637/3-2Z
	7	2	0,178	0,057	0,002	160 000	100 000	0,3	W 618/3
	7	3	0,178	0,057	0,002	160 000	80 000	0,41	▶ W 638/3-2Z
4	8	3	0,225	0,072	0,003	150 000	75 000	0,61	▶ W 619/3-2Z
	8	4	0,319	0,09	0,004	150 000	75 000	0,82	▶ W 639/3-2Z
	10	4	0,358	0,11	0,005	–	40 000	1,5	W 623-2RS1
	10	4	0,358	0,11	0,005	140 000	70 000	1,6	▶ W 623-2Z
4	7	2,5	0,143	0,053	0,002	150 000	75 000	0,31	W 627/4-2Z
	9	2,5	0,364	0,114	0,005	140 000	85 000	0,6	▶ W 618/4
	9	4	0,364	0,114	0,005	140 000	70 000	0,93	▶ W 638/4-2Z
4	11	4	0,54	0,176	0,008	130 000	63 000	1,65	▶ W 619/4-2Z
	12	4	0,54	0,176	0,008	–	36 000	2,15	W 604-2RS1
	12	4	0,54	0,176	0,008	130 000	63 000	2,15	▶ W 604-2Z
4	12	4	0,54	0,176	0,008	130 000	80 000	2	W 604
	13	5	0,741	0,25	0,011	–	32 000	3,05	▶ W 624-2RS1
	13	5	0,741	0,25	0,011	110 000	56 000	2,95	▶ W 624-2Z
4	16	5	0,761	0,265	0,011	–	30 000	5,15	W 634-2RS1
	16	5	0,761	0,265	0,011	100 000	50 000	5,15	W 634-2Z
5	8	2,5	0,121	0,045	0,002	140 000	70 000	0,41	W 627/5-2Z
	11	3	0,403	0,143	0,006	120 000	75 000	1,2	W 618/5
	11	4	0,403	0,143	0,006	120 000	60 000	1,55	W 628/5-2Z
5	11	5	0,403	0,143	0,006	120 000	60 000	1,85	▶ W 638/5-2Z
	13	4	0,761	0,335	0,014	–	32 000	2,35	▶ W 619/5-2RS1
	13	4	0,761	0,335	0,014	110 000	56 000	2,35	▶ W 619/5-2Z
5	13	4	0,761	0,335	0,014	110 000	70 000	2,1	W 619/5
	14	5	0,761	0,26	0,011	–	30 000	3,45	W 605-2RS1
5	14	5	0,761	0,26	0,011	110 000	53 000	3,35	W 605-2Z

▶ Popular item

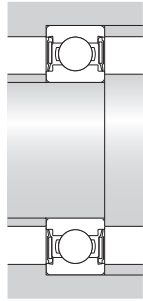
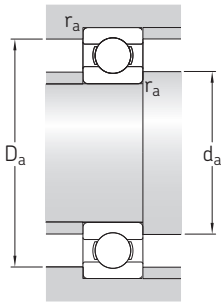

Dimensions			Abutment and fillet dimensions							Calculation factors	
d	d ₁ ≈	d ₂ ≈	D ₁ ≈	D ₂ ≈	r _{1,2} min.	d _a min.	d _a max.	D _a max.	r _a max.	k _r	f ₀
mm						mm				–	
1	1,5	–	2,5	–	0,05	1,4	–	2,6	0,05	0,02	5,6
1,5	2,1	–	3,1	–	0,05	2	–	3,6	0,05	0,02	6,4
	2,1	–	–	3,5	0,05	1,9	2,1	3,6	0,05	0,02	6,4
2	2,7	–	3,9	–	0,08	2,5	–	4,4	0,08	0,02	6,5
	2,7	–	–	4,4	0,08	2,5	2,6	4,5	0,08	0,02	6,5
	3	–	–	5,4	0,15	2,9	2,9	5,4	0,15	0,025	6
2,5	3,7	–	–	5,4	0,08	3,1	3,6	5,5	0,08	0,02	7,1
3	–	3,7	–	5,4	0,1	3,6	3,6	5,5	0,1	0,02	7,1
	4,2	–	5,8	–	0,1	3,8	–	6,2	0,1	0,02	7,1
	–	3,8	–	6,4	0,1	3,7	3,8	6,5	0,1	0,02	7,1
4	5	–	–	7,4	0,1	3,8	4,9	7,5	0,1	0,025	7,2
	4,3	–	–	7,3	0,15	3,9	4,3	7,3	0,15	0,025	6,1
	–	4,3	–	8	0,15	3,9	4,3	8,8	0,15	0,03	6,3
	–	4,3	–	8	0,15	3,9	4,3	8,8	0,15	0,03	6,3
5	4,8	–	–	6,5	0,1	4,6	4,7	6,5	0,1	0,015	7,6
	5,2	–	7,5	–	0,1	4,8	–	8,2	0,1	0,02	6,5
	5,2	–	–	8,1	0,1	4,8	5,1	8,2	0,1	0,02	6,5
	–	5,6	–	9,9	0,15	5,2	5,5	10	0,15	0,025	6,4
	–	5,6	–	9,9	0,2	5,3	5,5	10,4	0,2	0,03	6,4
	–	5,6	–	9,9	0,2	5,3	5,5	10,4	0,2	0,03	6,4
	–	5,6	–	9,9	0,2	5,3	–	10,4	0,2	0,03	6,4
	–	6	–	11,4	0,2	5,6	5,9	11,5	0,2	0,03	6,4
	–	6	–	11,4	0,2	5,6	5,9	11,5	0,2	0,03	6,4
	–	6,7	–	13	0,3	6	6,6	14	0,3	0,035	6,8
	–	6,7	–	13	0,3	6	6,6	14	0,3	0,035	6,8
	6	5,8	–	–	7,5	0,1	5,6	5,7	7,5	0,1	0,015
6,8		–	9,2	–	0,15	6,2	–	9,8	0,15	0,02	7,1
6,8		–	–	9,9	0,15	6,2	6,7	10	0,15	0,02	7,1
–		6,2	–	9,9	0,15	5,9	6,1	10	0,15	0,02	7,1
–		6,6	–	11,2	0,2	6,3	6,5	11,4	0,2	0,025	11
–		6,6	–	11,2	0,2	6,3	6,5	11,4	0,2	0,025	11
–		6,6	–	11,2	0,2	6,3	–	11,4	0,2	0,025	11
–		6,9	–	12,2	0,2	6,6	6,8	12,4	0,2	0,03	6,6
–		6,9	–	12,2	0,2	6,6	6,8	12,4	0,2	0,03	6,6

1.4 Stainless steel deep groove ball bearings

d 5 – 8 mm

1.4

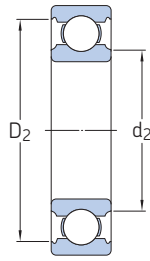
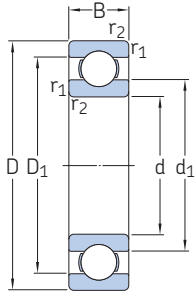

2Z



2Z



2ZS



2RS1

Principal dimensions			Basic load ratings		Fatigue load limit	Speed ratings		Mass	Designation
d	D	B	dynamic	static		Reference speed	Limiting speed		
mm			C	C ₀	P _u	r/min		g	–
5	16	5	1,43	0,63	0,027	–	28 000	4,85	▶ W 625-2RS1 ▶ W 625-2Z W 625
	cont.	16	5	1,43	0,63	0,027	100 000	50 000	
		16	5	1,43	0,63	0,027	100 000	63 000	
6	10	3	0,286	0,112	0,005	120 000	60 000	0,72	W 627/6-2Z
	13	3,5	0,618	0,224	0,01	110 000	67 000	1,8	▶ W 618/6
	13	5	0,618	0,224	0,01	–	30 000	2,55	W 628/6-2RS1
	13	5	0,618	0,224	0,01	110 000	53 000	2,55	▶ W 628/6-2Z
	15	5	0,761	0,265	0,011	100 000	50 000	3,85	▶ W 619/6-2Z
	15	5	0,761	0,265	0,011	100 000	63 000	3,5	W 619/6
	17	6	1,95	0,83	0,036	–	26 000	5,8	W 606-2RS1
	17	6	1,95	0,83	0,036	95 000	48 000	6	▶ W 606-2Z
	19	6	1,53	0,585	0,025	–	24 000	7,65	▶ W 626-2RS1
	19	6	1,53	0,585	0,025	85 000	43 000	7,75	▶ W 626-2Z
	19	6	1,53	0,585	0,025	85 000	56 000	7,1	▶ W 626
	7	11	3	0,26	0,104	0,004	110 000	56 000	0,72
14		3,5	0,663	0,26	0,011	100 000	63 000	2	W 618/7
14		5	0,663	0,26	0,011	100 000	50 000	2,75	W 628/7-2Z
17		5	0,923	0,365	0,016	90 000	45 000	5,1	W 619/7-2Z
17		5	0,923	0,365	0,016	90 000	56 000	4,8	W 619/7
19		6	1,53	0,585	0,025	–	24 000	7,25	▶ W 607-2RS1
19		6	1,53	0,585	0,025	85 000	43 000	7,35	W 607-2Z
19		6	1,53	0,585	0,025	85 000	56 000	6,7	W 607
22		7	1,99	0,78	0,034	–	22 000	12,5	W 627-2RS1
22		7	1,99	0,78	0,034	75 000	38 000	12,5	W 627-2Z
22		7	1,99	0,78	0,034	75 000	48 000	11,5	W 627
8		12	3,5	0,312	0,14	0,006	100 000	53 000	1,05
	16	4	0,715	0,3	0,012	90 000	56 000	3,1	▶ W 618/8
	16	5	0,715	0,3	0,012	–	26 000	3,85	▶ W 628/8-2RS1
	16	5	0,715	0,3	0,012	90 000	45 000	3,75	▶ W 628/8-2Z
	16	6	0,715	0,3	0,012	90 000	45 000	4,6	▶ W 638/8-2Z
	19	6	1,25	0,455	0,02	–	24 000	6,65	▶ W 619/8-2RS1
	19	6	1,25	0,455	0,02	85 000	43 000	6,75	▶ W 619/8-2Z
	19	6	1,25	0,455	0,02	85 000	53 000	6,1	W 619/8
	22	7	1,99	0,78	0,034	–	22 000	11,5	▶ W 608-2RS1

▶ Popular item

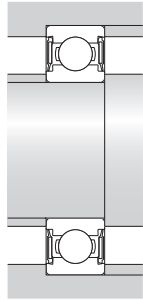
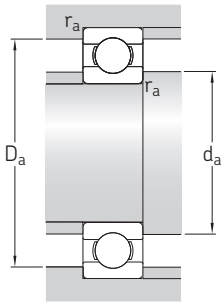

Dimensions						Abutment and fillet dimensions				Calculation factors	
d	d ₁ ≈	d ₂ ≈	D ₁ ≈	D ₂ ≈	r _{1,2} min.	d _a min.	d _a max.	D _a max.	r _a max.	k _r	f ₀
mm						mm				–	
5 cont.	–	7,5	–	13,4	0,3	7	7,4	14	0,3	0,03	12
	–	7,5	–	13,4	0,3	7	7,4	14	0,3	0,03	12
	–	7,5	–	13,4	0,3	7	–	14	0,3	0,03	12
6	7	–	–	9,4	0,1	6,8	6,9	9,5	0,1	0,015	7,8
	8	–	11	–	0,15	7,2	–	11,8	0,15	0,02	7
	–	7,4	–	11,7	0,15	7,2	7,3	11,8	0,15	0,02	7
	–	7,4	–	11,7	0,15	7,2	7,3	11,8	0,15	0,02	7
	–	7,5	–	13	0,2	7,3	7,4	13,4	0,2	0,025	6,8
	–	7,5	–	13	0,2	7,3	–	13,4	0,2	0,025	6,8
	–	8,2	–	14,8	0,3	7,7	8,1	15	0,3	0,03	11
	–	8,2	–	14,8	0,3	7,7	8,1	15	0,3	0,03	11
	–	8,5	–	16,5	0,3	8	8,4	17	0,3	0,03	7,9
	–	8,5	–	16,5	0,3	8	8,4	17	0,3	0,03	7,9
	–	8,5	–	16,5	0,3	8	–	17	0,3	0,03	7,9
	7	8	–	–	10,3	0,15	7,9	7,9	10,3	0,15	0,015
9		–	12	–	0,15	8,2	–	12,8	0,15	0,02	7,2
–		8,5	–	12,7	0,15	8,2	8,4	12,8	0,15	0,02	7,2
–		9,2	–	14,3	0,3	8,7	9,1	15	0,3	0,025	7,3
–		9,2	–	14,3	0,3	8,7	–	15	0,3	0,025	7,3
–		9	–	16,5	0,3	8,7	8,9	17	0,3	0,03	7,9
–		9	–	16,5	0,3	8,7	8,9	17	0,3	0,03	7,9
–		9	–	16,5	0,3	8,7	–	17	0,3	0,03	7,9
–		10,5	–	19,1	0,3	9	10,4	20	0,3	0,03	7,2
–		10,5	–	19,1	0,3	9	10,4	20	0,3	0,03	7,2
–		10,5	–	19,1	0,3	9	–	20	0,3	0,03	7,2
8		9	–	–	11,4	0,1	8,6	8,9	11,5	0,1	0,02
	10,5	–	13,5	–	0,2	9,6	–	14,4	0,2	0,02	7,5
	–	9,6	–	14,2	0,2	9,5	9,6	14,4	0,2	0,02	7,5
	–	9,6	–	14,2	0,2	9,5	9,6	14,4	0,2	0,02	7,5
	–	9,6	–	14,2	0,2	9,5	9,6	14,4	0,2	0,02	7,5
	–	9,8	–	16,7	0,3	9,7	9,7	17	0,3	0,025	6,6
	–	9,8	–	16,7	0,3	9,7	9,7	17	0,3	0,025	6,6
	–	9,8	–	16,7	0,3	9,7	–	17	0,3	0,025	6,6
	–	9,8	–	16,7	0,3	9,7	–	17	0,3	0,025	6,6
	–	10,5	–	19,1	0,3	10	10,4	20	0,3	0,03	7,2
	–	10,5	–	19,1	0,3	10	10,4	20	0,3	0,03	7,2

1.4 Stainless steel deep groove ball bearings

d 8 – 12 mm

1.4

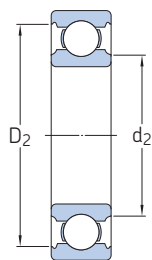
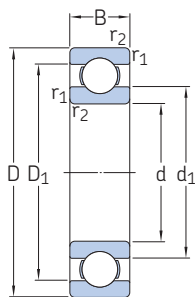

2Z



2Z



2RS1



2RS1

Principal dimensions			Basic load ratings		Fatigue load limit	Speed ratings		Mass	Designation	
d	D	B	dynamic C	static C ₀		Reference speed	Limiting speed			
mm			kN		kN	r/min	g	–		
8 cont.	22	7	1,99	0,78	0,034	75 000	38 000	11,5	▶ W 608-2Z	
	22	7	1,99	0,78	0,034	75 000	48 000	11	▶ W 608	
	24	8	2,47	1,12	0,048	70 000	36 000	17,5	W 628-2Z	
9	17	4	0,761	0,335	0,014	85 000	53 000	3,4	W 618/9	
	17	5	0,761	0,335	0,014	–	24 000	4,2	▶ W 628/9-2RS1	
	17	5	0,761	0,335	0,014	85 000	43 000	4,2	W 628/9-2Z	
	20	6	1,95	0,93	0,045	80 000	40 000	7,65	▶ W 619/9-2Z	
	20	6	1,95	0,93	0,045	80 000	50 000	7	W 619/9	
	24	7	2,03	0,815	0,036	–	20 000	14	▶ W 609-2RS1	
	24	7	2,03	0,815	0,036	70 000	36 000	14	W 609-2Z	
	24	7	2,03	0,815	0,036	70 000	43 000	13	W 609	
	26	8	3,97	1,96	0,083	–	19 000	19	▶ W 629-2RS1	
	26	8	3,97	1,96	0,083	67 000	32 000	19	W 629-2Z	
	10	19	5	1,48	0,83	0,036	–	22 000	5,2	▶ W 61800-2RS1
		19	5	1,48	0,83	0,036	80 000	38 000	5,1	▶ W 61800-2Z
19		5	1,48	0,83	0,036	80 000	48 000	4,8	W 61800	
19		7	1,48	0,83	0,036	80 000	38 000	7,1	▶ W 63800-2Z	
22		6	2,34	1,25	0,054	–	20 000	9,3	▶ W 61900-2RS1	
22		6	2,34	1,25	0,054	70 000	36 000	9,4	▶ W 61900-2Z	
22		6	2,34	1,25	0,054	70 000	45 000	8,7	W 61900	
26		8	3,97	1,96	0,083	–	19 000	18,5	▶ W 6000-2RS1	
26		8	3,97	1,96	0,083	67 000	32 000	18,5	▶ W 6000-2Z	
26		8	3,97	1,96	0,083	67 000	40 000	17	▶ W 6000	
30		9	4,36	2,32	0,1	–	16 000	30	▶ W 6200-2RS1	
30		9	4,36	2,32	0,1	60 000	30 000	30,5	▶ W 6200-2Z	
30		9	4,36	2,32	0,1	60 000	36 000	28,5	W 6200	
35		11	7,02	3,4	0,146	–	15 000	52,5	▶ W 6300-2RS1	
35		11	7,02	3,4	0,146	53 000	26 000	53	W 6300-2Z	
35	11	7,02	3,4	0,146	53 000	34 000	49,5	W 6300		
12	21	5	1,51	0,9	0,039	–	20 000	6	▶ W 61801-2RS1	
	21	5	1,51	0,9	0,039	70 000	36 000	5,7	W 61801-2Z	
	24	6	2,51	1,46	0,062	–	19 000	10,5	▶ W 61901-2RS1	
	24	6	2,51	1,46	0,062	67 000	32 000	11	▶ W 61901-2Z	
	24	6	2,51	1,46	0,062	67 000	40 000	9,8	W 61901	
	28	8	4,42	2,36	0,102	–	16 000	20	▶ W 6001-2RS1	

▶ Popular item

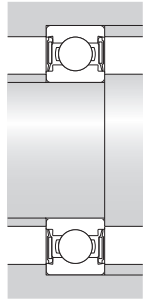
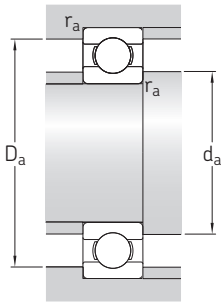

Dimensions						Abutment and fillet dimensions				Calculation factors	
d	d ₁ ≈	d ₂ ≈	D ₁ ≈	D ₂ ≈	r _{1,2} min.	d _a min.	d _a max.	D _a max.	r _a max.	k _r	f ₀
mm						mm				–	
8 cont.	–	10,5	–	19,1	0,3	10	10,4	20	0,3	0,03	7,2
	–	10,5	–	19,1	0,3	10	–	20	0,3	0,03	7,2
	–	11,9	–	19,9	0,3	10	11,8	22	0,3	0,03	10
9	11,5	–	14,5	–	0,2	10,6	–	15,4	0,2	0,02	7,7
	–	10,7	–	15,2	0,2	10,3	10,6	15,4	0,2	0,02	7,7
	–	10,7	–	15,2	0,2	10,3	10,6	15,4	0,2	0,02	7,7
	11,6	–	–	17,5	0,3	11	11,1	18	0,3	0,025	12
	11,6	–	–	17,5	0,3	11	–	18	0,3	0,025	12
	–	12,1	–	20,5	0,3	11	12	22	0,3	0,03	7,5
	–	12,1	–	20,5	0,3	11	12	22	0,3	0,03	7,5
	–	12,1	–	20,5	0,3	11	–	22	0,3	0,03	7,5
	–	13,9	–	22,4	0,6	13	13,8	22,6	0,6	0,03	12
	–	13,9	–	22,4	0,6	13	13,8	22,6	0,6	0,03	12
10	–	11,8	–	17,2	0,3	11,5	11,5	17,5	0,3	0,02	15
	–	11,8	–	17,2	0,3	11,5	11,5	17,5	0,3	0,02	15
	–	11,8	–	17,2	0,3	11,5	–	17,5	0,3	0,02	15
	–	11,8	–	17,2	0,3	11,5	11,5	17,5	0,3	0,02	15
	–	13,2	–	19,4	0,3	12	13	20	0,3	0,025	14
	–	13,2	–	19,4	0,3	12	13	20	0,3	0,025	14
	–	13,2	–	19,4	0,3	12	–	20	0,3	0,025	14
	–	13,9	–	22,4	0,3	12	13,5	24	0,3	0,03	12
	–	13,9	–	22,4	0,3	12	13,5	24	0,3	0,03	12
	–	13,9	–	22,4	0,3	12	–	24	0,3	0,03	12
	–	15,3	–	25,3	0,6	14	15	26	0,6	0,03	13
	–	15,3	–	25,3	0,6	14	15	26	0,6	0,03	13
	–	15,3	–	25,3	0,6	14	–	26	0,6	0,03	13
	17,7	–	–	29,3	0,6	14	17,5	31	0,6	0,035	11
	17,7	–	–	29,3	0,6	14	17,5	31	0,6	0,035	11
17,7	–	–	29,3	0,6	14	–	31	0,6	0,035	11	
12	–	13,8	–	19,2	0,3	13,5	13,5	19,5	0,3	0,02	13
	–	13,8	–	19,2	0,3	13,5	13,5	19,5	0,3	0,02	13
	–	15,3	–	21,4	0,3	14	15	22	0,3	0,025	15
	–	15,3	–	21,4	0,3	14	15	22	0,3	0,025	15
	–	15,3	–	21,4	0,3	14	–	22	0,3	0,025	15
	–	16	–	25,2	0,3	14	15,5	26	0,3	0,03	13

1.4 Stainless steel deep groove ball bearings

d 12 – 17 mm

1.4

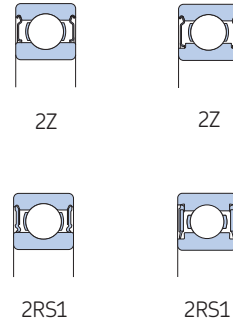
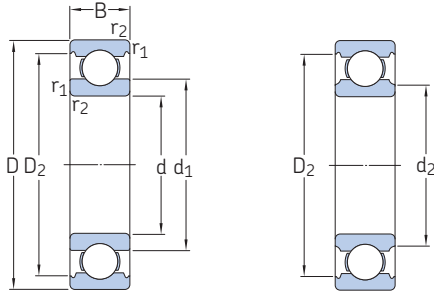
Principal dimensions			Basic load ratings		Fatigue load limit	Speed ratings		Mass	Designation	
d	D	B	dynamic	static		Reference speed	Limiting speed			
			C	C ₀	P _u	r/min		g	–	
mm			kN		kN					
12 cont.	28	8	4,42	2,36	0,102	60 000	30 000	20	▶ W 6001-2Z	
	28	8	4,42	2,36	0,102	60 000	36 000	18	▶ W 6001	
	32	10	5,72	3	0,127	–	15 000	36	▶ W 6201-2RS1	
	32	10	5,72	3	0,127	53 000	28 000	36	▶ W 6201-2Z	
	32	10	5,72	3	0,127	53 000	34 000	33,5	W 6201	
	37	12	8,32	4,15	0,176	–	14 000	58,5	▶ W 6301-2RS1	
	37	12	8,32	4,15	0,176	48 000	24 000	59,5	W 6301-2Z	
	37	12	8,32	4,15	0,176	48 000	30 000	55,5	W 6301	
	15	24	5	1,65	1,08	0,048	–	17 000	7,1	W 61802-2RS1
		24	5	1,65	1,08	0,048	60 000	30 000	6,7	W 61802-2Z
28		7	3,71	2,24	0,095	–	16 000	15,5	▶ W 61902-2RS1	
28		7	3,71	2,24	0,095	56 000	28 000	16	▶ W 61902-2Z	
28		7	3,71	2,24	0,095	56 000	34 000	14,5	W 61902	
32		9	4,88	2,8	0,12	–	14 000	28,5	▶ W 6002-2RS1	
32		9	4,88	2,8	0,12	50 000	26 000	29	▶ W 6002-2Z	
32		9	4,88	2,8	0,12	50 000	32 000	26,5	W 6002	
35		11	6,37	3,6	0,156	–	13 000	44	▶ W 6202-2RS1	
35		11	6,37	3,6	0,156	48 000	24 000	44	▶ W 6202-2Z	
35		11	6,37	3,6	0,156	48 000	30 000	41,5	W 6202	
42		13	9,95	5,4	0,232	–	11 000	81	▶ W 6302-2RS1	
42		13	9,95	5,4	0,232	40 000	20 000	82	W 6302-2Z	
42		13	9,95	5,4	0,232	40 000	26 000	77	W 6302	
17	26	5	1,78	1,27	0,054	–	16 000	8	W 61803-2RS1	
	26	5	1,78	1,27	0,054	56 000	28 000	7,6	▶ W 61803-2Z	
	30	7	3,97	2,55	0,108	–	14 000	16,5	▶ W 61903-2RS1	
	30	7	3,97	2,55	0,108	50 000	24 000	17	▶ W 61903-2Z	
	30	7	3,97	2,55	0,108	50 000	32 000	15,5	W 61903	
	35	10	4,94	3,15	0,137	–	13 000	38	▶ W 6003-2RS1	
	35	10	4,94	3,15	0,137	45 000	22 000	38,5	▶ W 6003-2Z	
	35	10	4,94	3,15	0,137	45 000	28 000	36	W 6003	
	40	12	8,06	4,75	0,2	–	12 000	64,5	▶ W 6203-2RS1	
	40	12	8,06	4,75	0,2	40 000	20 000	65,5	▶ W 6203-2Z	
	40	12	8,06	4,75	0,2	40 000	26 000	61,5	W 6203	
	47	14	11,7	6,55	0,28	–	10 000	112	▶ W 6303-2RS1	
	47	14	11,7	6,55	0,28	36 000	18 000	113	W 6303-2Z	
	47	14	11,7	6,55	0,28	36 000	22 000	107	W 6303	

▶ Popular item

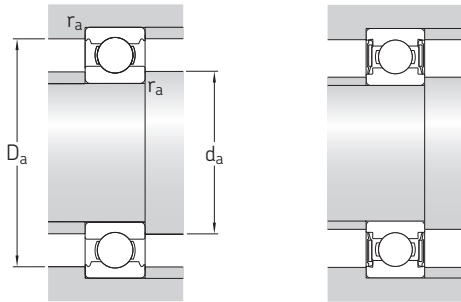

Dimensions						Abutment and fillet dimensions				Calculation factors	
d	d ₁ ≈	d ₂ ≈	D ₁ ≈	D ₂ ≈	r _{1,2} min.	d _a min.	d _a max.	D _a max.	r _a max.	k _r	f ₀
mm						mm				–	
12 cont.	–	16	–	25,2	0,3	14	15,5	26	0,3	0,03	13
	–	16	–	25,2	0,3	14	–	26	0,3	0,03	13
	18,5	–	–	28	0,6	16	18	28,5	0,6	0,03	12
	18,5	–	–	28	0,6	16	18	28,5	0,6	0,03	12
	18,5	–	–	28	0,6	16	–	28,5	0,6	0,03	12
	19,3	–	–	32	1	17	19	32,5	1	0,035	11
	19,3	–	–	32	1	17	19	32,5	1	0,035	11
	19,3	–	–	32	1	17	–	32,5	1	0,035	11
	19,3	–	–	32	1	17	–	32,5	1	0,035	11
	19,3	–	–	32	1	17	–	32,5	1	0,035	11
15	–	16,8	–	22,2	0,3	16,5	16,5	22,5	0,3	0,02	14
	–	16,8	–	22,2	0,3	16,5	16,5	22,5	0,3	0,02	14
	18,8	–	–	25,3	0,3	17	18,5	26	0,3	0,025	14
	18,8	–	–	25,3	0,3	17	18,5	26	0,3	0,025	14
	18,8	–	–	25,3	0,3	17	–	26	0,3	0,025	14
	–	18,6	–	29,1	0,3	17	18,5	30	0,3	0,03	14
	–	18,6	–	29,1	0,3	17	–	30	0,3	0,03	14
	21,7	–	–	31,4	0,6	19	21,5	32	0,6	0,03	13
	21,7	–	–	31,4	0,6	19	21,5	32	0,6	0,03	13
	21,7	–	–	31,4	0,6	19	–	32	0,6	0,03	13
	24,5	–	–	36,8	1	20	24	37,5	1	0,035	12
	24,5	–	–	36,8	1	20	24	37,5	1	0,035	12
	24,5	–	–	36,8	1	20	–	37,5	1	0,035	12
	24,5	–	–	36,8	1	20	–	37,5	1	0,035	12
17	–	18,8	–	24,2	0,3	18,5	18,5	24,5	0,3	0,02	14
	–	18,8	–	24,2	0,3	18,5	18,5	24,5	0,3	0,02	14
	21	–	–	27,8	0,3	19	20,5	28,5	0,3	0,025	15
	21	–	–	27,8	0,3	19	20,5	28,5	0,3	0,025	15
	21	–	–	27,8	0,3	19	–	28,5	0,3	0,025	15
	23,5	–	–	31,9	0,3	19	23	33	0,3	0,03	14
	23,5	–	–	31,9	0,3	19	23	33	0,3	0,03	14
	23,5	–	–	31,9	0,3	19	–	33	0,3	0,03	14
	24,9	–	–	35,8	0,6	21	24,5	37,5	0,6	0,03	13
	24,9	–	–	35,8	0,6	21	24,5	37,5	0,6	0,03	13
	24,9	–	–	35,8	0,6	21	–	37,5	0,6	0,03	13
	27,5	–	–	41,1	1	22	27	42	1	0,035	12
	27,5	–	–	41,1	1	22	27	42	1	0,035	12
	27,5	–	–	41,1	1	22	–	42	1	0,035	12
	27,5	–	–	41,1	1	22	–	42	1	0,035	12

1.4 Stainless steel deep groove ball bearings

d 20 – 30 mm

1.4

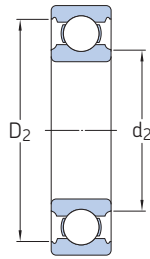
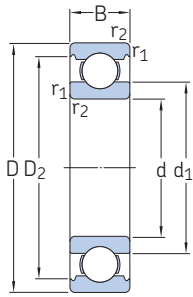

2Z



2Z



2RS1



2RS1

Principal dimensions			Basic load ratings		Fatigue load limit	Speed ratings		Mass	Designation
d	D	B	C	C ₀	P _u	Reference speed	Limiting speed		
mm			kN		kN	r/min		g	–
20	32	7	3,12	2,08	0,09	–	13 000	17	▶ W 61804-2RS1
	32	7	3,12	2,08	0,09	48 000	24 000	17	▶ W 61804-2Z
	37	9	5,53	3,65	0,156	–	12 000	35,5	▶ W 61904-2RS1
	37	9	5,53	3,65	0,156	43 000	26 000	32,5	W 61904
	42	12	8,06	5	0,212	–	11 000	64,5	▶ W 6004-2RS1
	42	12	8,06	5	0,212	38 000	19 000	64,5	▶ W 6004-2Z
	42	12	8,06	5	0,212	38 000	24 000	60,5	W 6004
	47	14	10,8	6,55	0,28	–	10 000	105	▶ W 6204-2RS1
	47	14	10,8	6,55	0,28	34 000	17 000	106	▶ W 6204-2Z
	47	14	10,8	6,55	0,28	34 000	22 000	100	W 6204
	52	15	13,8	7,8	0,335	–	9 500	143	▶ W 6304-2RS1
	52	15	13,8	7,8	0,335	34 000	17 000	144	W 6304-2Z
	52	15	13,8	7,8	0,335	34 000	20 000	136	W 6304
	25	37	7	3,38	2,5	0,108	–	11 000	21
37		7	3,38	2,5	0,108	38 000	19 000	21	W 61805-2Z
42		9	6,05	4,5	0,193	–	10 000	39,5	▶ W 61905-2RS1
47		12	8,71	5,85	0,25	–	9 500	76,5	▶ W 6005-2RS1
47		12	8,71	5,85	0,25	32 000	16 000	77,5	▶ W 6005-2Z
47		12	8,71	5,85	0,25	32 000	20 000	71,5	W 6005
52		15	11,7	7,65	0,335	–	8 500	128	▶ W 6205-2RS1
52		15	11,7	7,65	0,335	30 000	15 000	130	▶ W 6205-2Z
52		15	11,7	7,65	0,335	30 000	19 000	122	▶ W 6205
62		17	17,8	11,2	0,48	–	7 500	234	▶ W 6305-2RS1
62		17	17,8	11,2	0,48	26 000	13 000	235	W 6305-2Z
62		17	17,8	11,2	0,48	26 000	17 000	224	W 6305
30	42	7	3,58	2,9	0,125	–	9 500	24	W 61806-2RS1
	47	9	6,24	5	0,212	–	8 500	47	▶ W 61906-2RS1
	47	9	6,24	5	0,212	30 000	19 000	43,5	W 61906
	55	13	11,4	8,15	0,355	–	8 000	112	▶ W 6006-2RS1
	55	13	11,4	8,15	0,355	28 000	14 000	113	▶ W 6006-2Z
	55	13	11,4	8,15	0,355	28 000	17 000	105	W 6006
	62	16	16,5	11,2	0,48	–	7 000	196	▶ W 6206-2RS1
	62	16	16,5	11,2	0,48	26 000	13 000	196	▶ W 6206-2Z
	62	16	16,5	11,2	0,48	26 000	16 000	186	W 6206

▶ Popular item

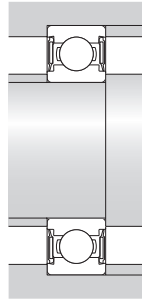
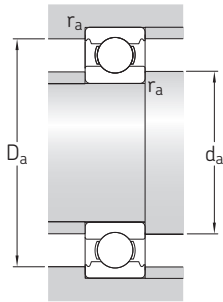

Dimensions						Abutment and fillet dimensions				Calculation factors		
d	d ₁ ≈	d ₂ ≈	D ₁ ≈	D ₂ ≈	r _{1,2} min.	d _a min.	d _a max.	D _a max.	r _a max.	k _r	f ₀	
mm						mm				–		
20	–	22,6	–	29,6	0,3	22	22,5	30,5	0,3	0,02	13	
	–	22,6	–	29,6	0,3	22	22,5	30,5	0,3	0,02	13	
	–	23,6	–	33,5	0,3	22	23,5	35	0,3	0,025	15	
	–	23,6	–	33,5	0,3	22	–	35	0,3	0,025	15	
	27,6	–	–	38,8	0,6	24	27,5	39,5	0,6	0,03	14	
	27,6	–	–	38,8	0,6	24	27,5	39,5	0,6	0,03	14	
	27,6	–	–	38,8	0,6	24	–	39,5	0,6	0,03	14	
	29,5	–	–	41	1	25	29	42	1	0,03	13	
	29,5	–	–	41	1	25	29	42	1	0,03	13	
	29,5	–	–	41	1	25	–	42	1	0,03	13	
	30	–	–	45,4	1,1	26,5	29,5	46	1	0,035	12	
	30	–	–	45,4	1,1	26,5	29,5	46	1	0,035	12	
	30	–	–	45,4	1,1	26,5	–	46	1	0,035	12	
	25	28,2	–	–	34,2	0,3	27	28	35	0,3	0,02	14
		28,2	–	–	34,2	0,3	27	28	35	0,3	0,02	14
30,9		–	–	39,5	0,3	27	30,5	40,5	0,3	0,025	15	
31,7		–	–	42,8	0,6	29	31,5	44,5	0,6	0,03	15	
31,7		–	–	42,8	0,6	29	31,5	44,5	0,6	0,03	15	
31,7		–	–	42,8	0,6	29	–	44,5	0,6	0,03	15	
34		–	–	45,8	1	30	33,5	47	1	0,03	14	
34		–	–	45,8	1	30	33,5	47	1	0,03	14	
34		–	–	45,8	1	30	–	47	1	0,03	14	
38,1		–	–	53,3	1,1	31,5	38	55	1	0,035	13	
38,1		–	–	53,3	1,1	31,5	38	55	1	0,035	13	
38,1		–	–	53,3	1,1	31,5	–	55	1	0,035	13	
30		33,1	–	–	39,2	0,3	32	33	40	0,3	0,02	14
		35,1	–	–	44,1	0,3	32	35	45	0,3	0,025	16
		35,1	–	–	44,1	0,3	32	–	45	0,3	0,025	16
	38	–	–	50	1	35	37,5	50	1	0,03	15	
	38	–	–	50	1	35	37,5	50	1	0,03	15	
	38	–	–	50	1	35	–	50	1	0,03	15	
	40,7	–	–	55,2	1	35	40,5	57	1	0,03	14	
	40,7	–	–	55,2	1	35	40,5	57	1	0,03	14	
	40,7	–	–	55,2	1	35	–	57	1	0,03	14	

1.4 Stainless steel deep groove ball bearings

d 30 – 50 mm

1.4

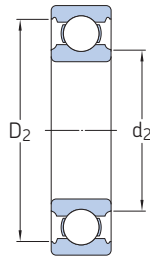
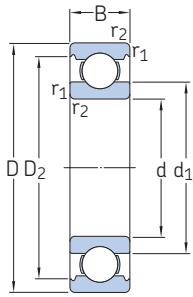

2Z



2Z



2RS1



2RS1

Principal dimensions			Basic load ratings		Fatigue load limit	Speed ratings		Mass	Designation
d	D	B	dynamic	static		Reference speed	Limiting speed		
			C	C ₀	P _u				
mm			kN		kN	r/min		g	–
30 cont.	72	19	22,9	15	0,64	–	6 300	346	▶ W 6306-2RS1
	72	19	22,9	15	0,64	22 000	11 000	345	▶ W 6306-2Z
	72	19	22,9	15	0,64	22 000	14 000	331	▶ W 6306
35	47	7	3,71	3,35	0,14	–	8 500	29,5	▶ W 61807-2RS1
	55	10	9,36	7,65	0,325	–	7 500	73,5	▶ W 61907-2RS1
	62	14	13,8	10,2	0,44	–	6 700	147	▶ W 6007-2RS1
	62	14	13,8	10,2	0,44	24 000	12 000	148	▶ W 6007-2Z
	62	14	13,8	10,2	0,44	24 000	15 000	138	▶ W 6007
	72	17	22,1	15,3	0,655	–	6 000	276	▶ W 6207-2RS1
	72	17	22,1	15,3	0,655	22 000	11 000	277	▶ W 6207-2Z
	72	17	22,1	15,3	0,655	22 000	14 000	262	▶ W 6207
	80	21	28,6	19	0,815	–	5 600	441	▶ W 6307-2RS1
	40	62	12	11,9	9,8	0,425	–	6 700	107
68		15	14,6	11,4	0,49	–	6 300	182	▶ W 6008-2RS1
68		15	14,6	11,4	0,49	22 000	11 000	183	▶ W 6008-2Z
68		15	14,6	11,4	0,49	22 000	14 000	172	▶ W 6008
80		18	25,1	17,6	0,75	–	5 600	359	▶ W 6208-2RS1
80		18	25,1	17,6	0,75	20 000	10 000	359	▶ W 6208-2Z
80		18	25,1	17,6	0,75	20 000	12 000	342	▶ W 6208
45		68	12	12,1	10,8	0,465	–	6 000	125
	75	16	18,2	15	0,64	–	5 600	236	▶ W 6009-2RS1
	75	16	18,2	15	0,64	20 000	10 000	237	▶ W 6009-2Z
	85	19	28,1	20,4	0,865	–	5 000	395	▶ W 6209-2RS1
	85	19	28,1	20,4	0,865	18 000	9 000	394	▶ W 6209-2Z
	50	65	7	5,07	5,5	0,236	–	6 000	51
80		16	19	16,6	0,71	–	5 000	256	▶ W 6010-2RS1
80		16	19	16,6	0,71	18 000	9 000	256	▶ W 6010-2Z
90		20	30,2	23,2	0,98	–	4 800	449	▶ W 6210-2RS1
90		20	30,2	23,2	0,98	17 000	8 500	453	▶ W 6210-2Z

▶ Popular item

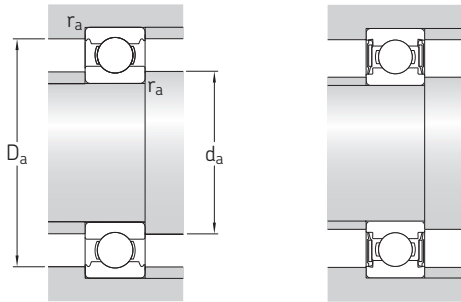

Dimensions						Abutment and fillet dimensions				Calculation factors	
d	d ₁ ≈	d ₂ ≈	D ₁ ≈	D ₂ ≈	r _{1,2} min.	d _a min.	d _a max.	D _a max.	r _a max.	k _r	f ₀
mm						mm				–	
30 cont.	44,9	–	–	62,4	1,1	36,5	44,5	65	1	0,035	13
	44,9	–	–	62,4	1,1	36,5	44,5	65	1	0,035	13
	44,9	–	–	62,4	1,1	36,5	–	65	1	0,035	13
35	38,2	–	–	43,7	0,3	37	38	45	0,3	0,02	14
	42,2	–	–	52,2	0,6	39	42	52	0,6	0,025	16
	44	–	–	57,1	1	40	43,5	57	1	0,03	15
	44	–	–	57,1	1	40	43,5	57	1	0,03	15
	44	–	–	57,1	1	40	–	57	1	0,03	15
	47,6	–	–	64,9	1,1	41,5	46,5	65	1	0,03	14
	47,6	–	–	64,9	1,1	41,5	46,5	65	1	0,03	14
	47,6	–	–	64,9	1,1	41,5	–	65	1	0,03	14
	–	46,7	–	71,6	1,5	43	46,5	73	1,5	0,035	13
	–	46,7	–	71,6	1,5	43	46,5	73	1,5	0,035	13
40	46,9	–	–	57,6	0,6	44	46,5	59	0,6	0,025	16
	49,2	–	–	62,5	1	45	49	63	1	0,03	15
	49,2	–	–	62,5	1	45	49	63	1	0,03	15
	49,2	–	–	62,5	1	45	–	63	1	0,03	15
	–	50,1	–	70,8	1,1	46,5	50	73	1	0,03	14
	–	50,1	–	70,8	1,1	46,5	50	73	1	0,03	14
	–	50,1	–	70,8	1,1	46,5	–	73	1	0,03	14
	–	50,1	–	70,8	1,1	46,5	–	73	1	0,03	14
45	–	50,3	–	63,2	0,6	49	52	64	0,6	0,025	16
	54,5	–	–	69	1	50	54	70	1	0,03	15
	54,5	–	–	69	1	50	54	70	1	0,03	15
	–	53,5	–	76,4	1,1	52	53	78	1	0,03	14
	–	53,5	–	76,4	1,1	52	53	78	1	0,03	14
50	54,6	–	–	61,6	0,3	52	54	63	0,3	0,02	15
	60	–	–	74,6	1	55	59	75	1	0,03	16
	60	–	–	74,6	1	55	59	75	1	0,03	16
	–	60	–	82,2	1,1	55	59	83	1	0,03	14
	–	60	–	82,2	1,1	55	59	83	1	0,03	14

1.5 Single row deep groove ball bearings with filling slots

d 25 – 50 mm

1.5

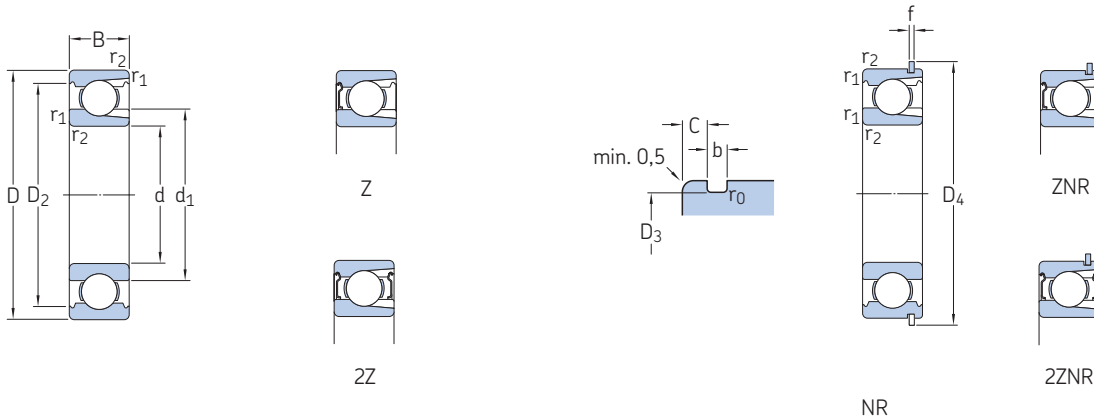

Principal dimensions			Basic load ratings		Fatigue load limit	Speed ratings		Mass	Designations		Snap ring
d	D	B	C	C ₀		Reference speed	Limiting speed		Bearing without a snap ring	with a snap ring	
mm			kN		kN	r/min		kg	-		
25	62	17	22,9	15,6	0,67	20 000	13 000	0,24	305	305 NR	SP 62
	62	17	22,9	15,6	0,67	20 000	13 000	0,24	305-Z	305-ZNR	SP 62
	62	17	22,9	15,6	0,67	20 000	10 400	0,24	305-2Z	305-2ZNR	SP 62
30	62	16	20,9	16,3	0,695	20 000	12 000	0,21	206	206 NR	SP 62
	62	16	20,9	16,3	0,695	20 000	12 000	0,21	206-Z	206-ZNR	SP 62
	62	16	20,9	16,3	0,695	20 000	9 600	0,21	206-2Z	206-2ZNR	SP 62
35	72	19	29,7	21,6	0,93	18 000	11 000	0,37	306	306 NR	SP 72
	72	19	29,7	21,6	0,93	18 000	11 000	0,37	306-Z	306-ZNR	SP 72
	72	19	29,7	21,6	0,93	18 000	8 800	0,37	306-2Z	306-2ZNR	SP 72
35	72	17	27,5	22	0,93	17 000	10 000	0,31	207	207 NR	SP 72
	72	17	27,5	22	0,93	17 000	10 000	0,31	207-Z	207-ZNR	SP 72
	72	17	27,5	22	0,93	17 000	8 000	0,31	207-2Z	207-2ZNR	SP 72
40	80	21	34,7	26,5	1,12	16 000	9 500	0,48	307	307 NR	SP 80
	80	21	34,7	26,5	1,12	16 000	9 500	0,48	307-Z	307-ZNR	SP 80
	80	21	34,7	26,5	1,12	16 000	7 600	0,48	307-2Z	307-2ZNR	SP 80
40	80	18	33,6	27	1,16	15 000	9 500	0,39	208	208 NR	SP 80
	80	18	33,6	27	1,16	15 000	9 500	0,39	208-Z	208-ZNR	SP 80
	80	18	33,6	27	1,16	15 000	7 600	0,39	208-2Z	208-2ZNR	SP 80
45	90	23	45,7	36	1,53	14 000	8 500	0,64	308	308 NR	SP 90
	90	23	45,7	36	1,53	14 000	8 500	0,64	308-Z	308-ZNR	SP 90
	90	23	45,7	36	1,53	14 000	6 800	0,64	308-2Z	308-2ZNR	SP 90
45	85	19	35,2	30	1,27	14 000	8 500	0,44	209	209 NR	SP 85
	85	19	35,2	30	1,27	14 000	8 500	0,44	209-Z	209-ZNR	SP 85
	85	19	35,2	30	1,27	14 000	6 800	0,44	209-2Z	209-2ZNR	SP 85
50	100	25	55	44	1,86	13 000	7 500	0,88	309	309 NR	SP 100
	100	25	55	44	1,86	13 000	7 500	0,88	309-Z	309-ZNR	SP 100
	100	25	55	44	1,86	13 000	6 000	0,88	309-2Z	309-2ZNR	SP 100
50	90	20	39,1	34,5	1,46	13 000	8 000	0,5	210	210 NR	SP 90
	90	20	39,1	34,5	1,46	13 000	8 000	0,5	210-Z	210-ZNR	SP 90
	90	20	39,1	34,5	1,46	13 000	6 400	0,5	210-2Z	210-2ZNR	SP 90
50	110	27	64,4	52	2,2	11 000	7 000	1,15	310	310 NR	SP 110
	110	27	64,4	52	2,2	11 000	7 000	1,15	310-Z	310-ZNR	SP 110
	110	27	64,4	52	2,2	11 000	5 600	1,15	310-2Z	310-2ZNR	SP 110

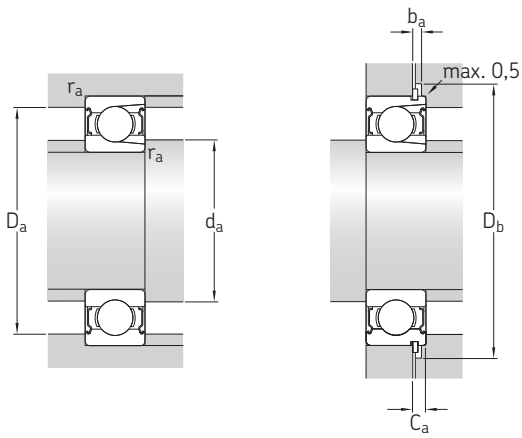

Dimensions										Abutment and fillet dimensions							Minimum load factor
d	d ₁ ≈	D ₂ ≈	D ₃	D ₄	b	f	C	r _{1,2} min.	r ₀ max.	d _a min.	d _a max.	D _a max.	D _b min.	b _a min.	C _a max.	r _a max.	k _r
mm										mm							-
25	36,6	52,7	59,61	67,7	1,9	1,7	3,28	1,1	0,6	32	-	55	69	2,2	4,98	1	0,05
	36,6	52,7	59,61	67,7	1,9	1,7	3,28	1,1	0,6	32	32,7	55	69	2,2	4,98	1	0,05
	36,6	52,7	59,61	67,7	1,9	1,7	3,28	1,1	0,6	32	32,7	55	69	2,2	4,98	1	0,05
30	40,3	54,06	59,61	67,7	1,9	1,7	3,28	1	0,6	35,6	-	56	69	2,2	4,98	1	0,04
	40,3	54,06	59,61	67,7	1,9	1,7	3,28	1	0,6	35,6	40,2	56	69	2,2	4,98	1	0,04
	40,3	54,06	59,61	67,7	1,9	1,7	3,28	1	0,6	35,6	40,2	56	69	2,2	4,98	1	0,04
	44,6	61,88	68,81	78,6	1,9	1,7	3,28	1,1	0,6	37	-	65	80	2,2	4,98	1	0,05
	44,6	61,88	68,81	78,6	1,9	1,7	3,28	1,1	0,6	37	44,5	65	80	2,2	4,98	1	0,05
	44,6	61,88	68,81	78,6	1,9	1,7	3,28	1,1	0,6	37	44,5	65	80	2,2	4,98	1	0,05
35	46,9	62,69	68,81	78,6	1,9	1,7	3,28	1,1	0,6	42	-	65	80	2,2	4,98	1	0,04
	46,9	62,69	68,81	78,6	1,9	1,7	3,28	1,1	0,6	42	46,8	65	80	2,2	4,98	1	0,04
	46,9	62,69	68,81	78,6	1,9	1,7	3,28	1,1	0,6	42	46,8	65	80	2,2	4,98	1	0,04
	49,5	69,2	76,81	86,6	1,9	1,7	3,28	1,5	0,6	44	-	71	88	2,2	4,98	1,5	0,05
	49,5	69,2	76,81	86,6	1,9	1,7	3,28	1,5	0,6	44	49,4	71	88	2,2	4,98	1,5	0,05
	49,5	69,2	76,81	86,6	1,9	1,7	3,28	1,5	0,6	44	49,4	71	88	2,2	4,98	1,5	0,05
40	52,6	69,8	76,81	86,6	1,9	1,7	3,28	1,1	0,6	47	-	73	88	2,2	4,98	1	0,04
	52,6	69,8	76,81	86,6	1,9	1,7	3,28	1,1	0,6	47	52	73	88	2,2	4,98	1	0,04
	52,6	69,8	76,81	86,6	1,9	1,7	3,28	1,1	0,6	47	52	73	88	2,2	4,98	1	0,04
	56,1	77,7	86,79	96,5	2,7	2,46	3,28	1,5	0,6	49	-	81	98	3	5,74	1,5	0,05
	56,1	77,7	86,79	96,5	2,7	2,46	3,28	1,5	0,6	49	56	81	98	3	5,74	1,5	0,05
	56,1	77,7	86,79	96,5	2,7	2,46	3,28	1,5	0,6	49	56	81	98	3	5,74	1,5	0,05
45	57,6	75,19	81,81	91,6	1,9	1,7	3,28	1,1	0,6	52	-	78	93	2,2	4,98	1	0,04
	57,6	75,19	81,81	91,6	1,9	1,7	3,28	1,1	0,6	52	57	78	93	2,2	4,98	1	0,04
	57,6	75,19	81,81	91,6	1,9	1,7	3,28	1,1	0,6	52	57	78	93	2,2	4,98	1	0,04
	62,1	86,7	96,8	106,5	2,7	2,46	3,28	1,5	0,6	54	-	91	108	3	5,74	1,5	0,05
	62,1	86,7	96,8	106,5	2,7	2,46	3,28	1,5	0,6	54	62	91	108	3	5,74	1,5	0,05
	62,1	86,7	96,8	106,5	2,7	2,46	3,28	1,5	0,6	54	62	91	108	3	5,74	1,5	0,05
50	62,5	81,61	86,79	96,5	2,7	2,46	3,28	1,1	0,6	57	-	83	98	3	5,74	1	0,04
	62,5	81,61	86,79	96,5	2,7	2,46	3,28	1,1	0,6	57	62	83	98	3	5,74	1	0,04
	62,5	81,61	86,79	96,5	2,7	2,46	3,28	1,1	0,6	57	62	83	98	3	5,74	1	0,04
	68,7	95,2	106,81	116,6	2,7	2,46	3,28	2	0,6	61	-	99	118	3	5,74	2	0,05
	68,7	95,2	106,81	116,6	2,7	2,46	3,28	2	0,6	61	68	99	118	3	5,74	2	0,05
	68,7	95,2	106,81	116,6	2,7	2,46	3,28	2	0,6	61	68	99	118	3	5,74	2	0,05

1.5 Single row deep groove ball bearings with filling slots

d 55 – 80 mm

1.5

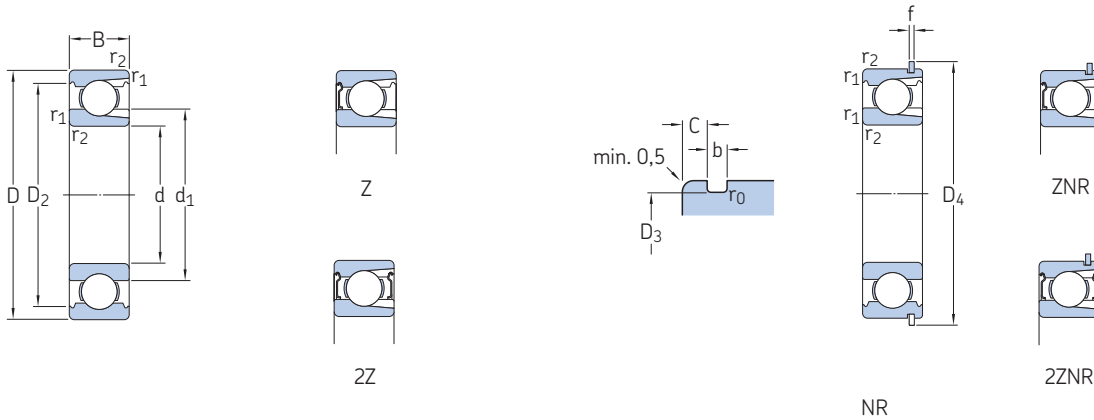

Principal dimensions			Basic load ratings		Fatigue load limit	Speed ratings		Mass	Designations		Snap ring
d	D	B	dynamic	static		Reference speed	Limiting speed		Bearing without a snap ring	with a snap ring	
mm			kN		kN	r/min		kg	-		
55	100	21	48,4	44	1,86	12 000	7 000	0,66	211	211 NR	SP 100
	100	21	48,4	44	1,86	12 000	7 000	0,66	211-Z	211-ZNR	SP 100
	100	21	48,4	44	1,86	12 000	5 600	0,66	211-2Z	211-2ZNR	SP 100
	120	29	79,2	67	2,85	10 000	6 300	1,5	311	311 NR	SP 120
	120	29	79,2	67	2,85	10 000	6 300	1,5	311-Z	311-ZNR	SP 120
	120	29	79,2	67	2,85	10 000	5 000	1,5	311-2Z	311-2ZNR	SP 120
60	110	22	56,1	50	2,12	11 000	6 700	0,85	212	212 NR	SP 110
	110	22	56,1	50	2,12	11 000	6 700	0,85	212-Z	212-ZNR	SP 110
	110	22	56,1	50	2,12	11 000	5 400	0,85	212-2Z	212-2ZNR	SP 110
	130	31	91,3	78	3,35	9 500	6 000	1,85	312	312 NR	SP 130
	130	31	91,3	78	3,35	9 500	6 000	1,85	312-Z	312-ZNR	SP 130
	130	31	91,3	78	3,35	9 500	4 800	1,85	312-2Z	312-2ZNR	SP 130
65	120	23	60,5	58,5	2,5	10 000	6 000	1,05	213	213 NR	SP 120
	120	23	60,5	58,5	2,5	10 000	6 000	1,05	213-Z	213-ZNR	SP 120
	120	23	60,5	58,5	2,5	10 000	4 800	1,05	213-2Z	213-2ZNR	SP 120
	140	33	102	90	3,75	9 000	5 300	2,3	313	313 NR	SP 140
	140	33	102	90	3,75	9 000	5 300	2,3	313-Z	313-ZNR	SP 140
	140	33	102	90	3,75	9 000	4 300	2,3	313-2Z	313-2ZNR	SP 140
70	125	24	66	65,5	2,75	9 500	5 600	1,15	214	214 NR	SP 125
	125	24	66	65,5	2,75	9 500	5 600	1,15	214-Z	214-ZNR	SP 125
	125	24	66	65,5	2,75	9 500	4 500	1,15	214-2Z	214-2ZNR	SP 125
	150	35	114	102	4,15	8 000	5 000	2,75	314	314 NR	SP 150
	150	35	114	102	4,15	8 000	5 000	2,75	314-Z	314-ZNR	SP 150
	150	35	114	102	4,15	8 000	4 000	2,75	314-2Z	314-2ZNR	SP 150
75	130	25	72,1	72	3	9 000	5 300	1,25	215	215 NR	SP 130
	130	25	72,1	72	3	9 000	5 300	1,25	215-Z	215-ZNR	SP 130
	130	25	72,1	72	3	9 000	4 300	1,25	215-2Z	215-2ZNR	SP 130
	160	37	125	116	4,55	7 500	4 800	3,25	315	-	-
	160	37	125	116	4,55	7 500	4 800	3,25	315-Z	-	-
	160	37	125	116	4,55	7 500	3 840	3,25	315-2Z	-	-
80	140	26	88	85	3,45	8 500	5 000	1,55	216	216 NR	SP 140
	140	26	88	85	3,45	8 500	5 000	1,55	216-Z	216-ZNR	SP 140
	140	26	88	85	3,45	8 500	4 000	1,55	216-2Z	216-2ZNR	SP 140
	170	39	138	129	4,9	7 000	4 300	3,95	316	-	-
	170	39	138	129	4,9	7 000	4 300	3,95	316-Z	-	-
	170	39	138	129	4,9	7 000	3 440	3,95	316-2Z	-	-

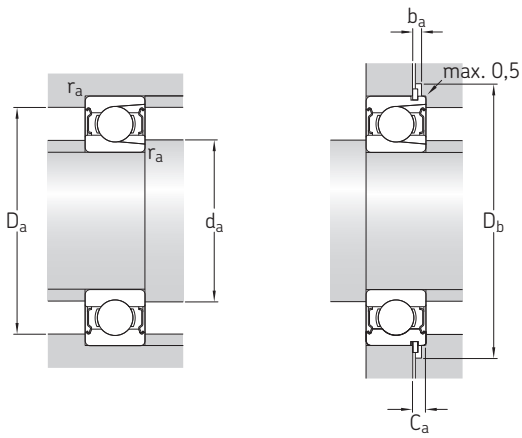

Dimensions					Abutment and fillet dimensions											Minimum load factor	
d	d ₁ ≈	D ₂ ≈	D ₃	D ₄	b	f	C	r _{1,2} min.	r ₀ max.	d _a min.	d _a max.	D _a max.	D _b min.	b _a min.	C _a max.	r _a max.	k _r
mm										mm						-	
55	69	89,4	96,8	106,5	2,7	2,46	3,28	1,5	0,6	64	-	91	108	3	5,74	1,5	0,04
	69	89,4	96,8	106,5	2,7	2,46	3,28	1,5	0,6	64	68	91	108	3	5,74	1,5	0,04
	69	89,4	96,8	106,5	2,7	2,46	3,28	1,5	0,6	64	68	91	108	3	5,74	1,5	0,04
	75,3	103,7	115,21	129,7	3,1	2,82	4,06	2	0,6	66	-	109	131	3,5	6,88	2	0,05
	75,3	103,7	115,21	129,7	3,1	2,82	4,06	2	0,6	66	75	109	131	3,5	6,88	2	0,05
	75,3	103,7	115,21	129,7	3,1	2,82	4,06	2	0,6	66	75	109	131	3,5	6,88	2	0,05
60	75,5	98	106,81	116,6	2,7	2,46	3,28	1,5	0,6	69	-	101	118	3	5,74	1,5	0,04
	75,5	98	106,81	116,6	2,7	2,46	3,28	1,5	0,6	69	75	101	118	3	5,74	1,5	0,04
	75,5	98	106,81	116,6	2,7	2,46	3,28	1,5	0,6	69	75	101	118	3	5,74	1,5	0,04
	81,8	112,2	125,22	139,7	3,1	2,82	4,06	2,1	0,6	72	-	118	141	3,5	6,88	2	0,05
	81,8	112,2	125,22	139,7	3,1	2,82	4,06	2,1	0,6	72	81	118	141	3,5	6,88	2	0,05
	81,8	112,2	125,22	139,7	3,1	2,82	4,06	2,1	0,6	72	81	118	141	3,5	6,88	2	0,05
65	83,3	105,8	115,21	129,7	3,1	2,82	4,06	1,5	0,6	74	-	111	131	3,5	6,88	1,5	0,04
	83,3	105,8	115,21	129,7	3,1	2,82	4,06	1,5	0,6	74	83	111	131	3,5	6,88	1,5	0,04
	83,3	105,8	115,21	129,7	3,1	2,82	4,06	1,5	0,6	74	83	111	131	3,5	6,88	1,5	0,04
	88,3	121,3	135,23	149,7	3,1	2,82	4,9	2,1	0,6	77	-	128	151	3,5	7,72	2	0,05
	88,3	121,3	135,23	149,7	3,1	2,82	4,9	2,1	0,6	77	88	128	151	3,5	7,72	2	0,05
	88,3	121,3	135,23	149,7	3,1	2,82	4,9	2,1	0,6	77	88	128	151	3,5	7,72	2	0,05
70	87	111	120,22	134,7	3,1	2,82	4,06	1,5	0,6	79	-	116	136	3,5	6,88	1,5	0,04
	87	111	120,22	134,7	3,1	2,82	4,06	1,5	0,6	79	87	116	136	3,5	6,88	1,5	0,04
	87	111	120,22	134,7	3,1	2,82	4,06	1,5	0,6	79	87	116	136	3,5	6,88	1,5	0,04
	93,7	129,9	145,24	159,7	3,1	2,82	4,9	2,1	0,6	82	-	138	162	3,5	7,72	2	0,05
	93,7	129,9	145,24	159,7	3,1	2,82	4,9	2,1	0,6	82	93	138	162	3,5	7,72	2	0,05
	93,7	129,9	145,24	159,7	3,1	2,82	4,9	2,1	0,6	82	93	138	162	3,5	7,72	2	0,05
75	92	116,5	125,22	139,7	3,1	2,82	4,06	1,5	0,6	84	-	121	141	3,5	6,88	1,5	0,04
	92	116,5	125,22	139,7	3,1	2,82	4,06	1,5	0,6	84	92	121	141	3,5	6,88	1,5	0,04
	92	116,5	125,22	139,7	3,1	2,82	4,06	1,5	0,6	84	92	121	141	3,5	6,88	1,5	0,04
	99,7	138,4	-	-	-	-	-	2,1	-	87	-	148	-	-	-	2	0,05
	99,7	138,4	-	-	-	-	-	2,1	-	87	99	148	-	-	-	2	0,05
	99,7	138,4	-	-	-	-	-	2,1	-	87	99	148	-	-	-	2	0,05
80	95,8	126,5	135,23	149,7	3,1	2,82	4,9	2	0,6	89	-	129	151	3,5	7,72	2	0,04
	95,8	126,5	135,23	149,7	3,1	2,82	4,9	2	0,6	89	88	129	151	3,5	7,72	2	0,04
	95,8	126,5	135,23	149,7	3,1	2,82	4,9	2	0,6	89	88	129	151	3,5	7,72	2	0,04
	106	146,9	-	-	-	-	-	2,1	-	92	-	158	-	-	-	2	0,05
	106	146,9	-	-	-	-	-	2,1	-	92	105	158	-	-	-	2	0,05
	106	146,9	-	-	-	-	-	2,1	-	92	105	158	-	-	-	2	0,05

1.5 Single row deep groove ball bearings with filling slots d 85 – 100 mm

1.5

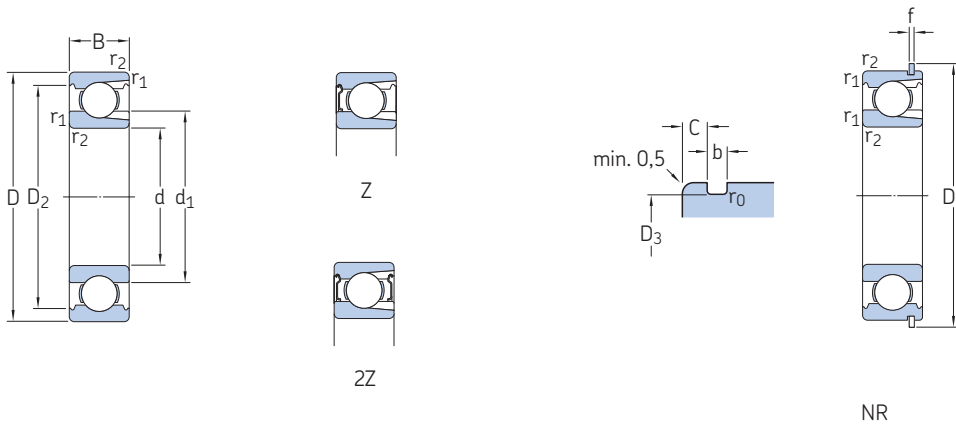

Principal dimensions			Basic load ratings		Fatigue load limit	Speed ratings		Mass	Designations		Snap ring
d	D	B	dynamic	static		Reference speed	Limiting speed		Bearing without a snap ring	with a snap ring	
mm			kN		kN	r/min		kg	-		
85	150	28	96,8	100	3,9	7 500	4 800	1,95	217	217 NR	SP 150
	150	28	96,8	100	3,9	7 500	4 800	1,95	217-Z	-	-
	150	28	96,8	100	3,9	7 500	3 900	1,95	217-2Z	-	-
	180	41	147	146	5,3	6 700	4 000	4,6	317	-	-
	180	41	147	146	5,3	6 700	4 000	4,6	317-Z	-	-
	180	41	147	146	5,3	6 700	3 200	4,6	317-2Z	-	-
90	160	30	112	114	4,3	7 000	4 300	2,35	218	218 NR	SP 160
	160	30	112	114	4,3	7 000	4 300	2,35	218-Z	-	-
	160	30	112	114	4,3	7 000	4 300	2,35	218-2Z	-	-
	190	43	157	160	5,7	6 300	4 000	5,4	318	-	-
	190	43	157	160	5,7	6 300	4 000	5,4	318-Z	-	-
	190	43	157	160	5,7	6 300	3 200	5,4	318-2Z	-	-
95	170	32	121	122	4,5	6 700	4 000	2,7	219	219 NR	SP 170
	170	32	121	122	4,5	6 700	4 000	2,7	219-Z	-	-
	170	32	121	122	4,5	6 700	4 000	2,7	219-2Z	-	-
100	180	34	134	140	5	6 300	4 000	3,45	220	-	-
	180	34	134	140	5	6 300	4 000	3,45	220-Z	-	-
	180	34	134	140	5	6 300	4 000	3,45	220-2Z	-	-

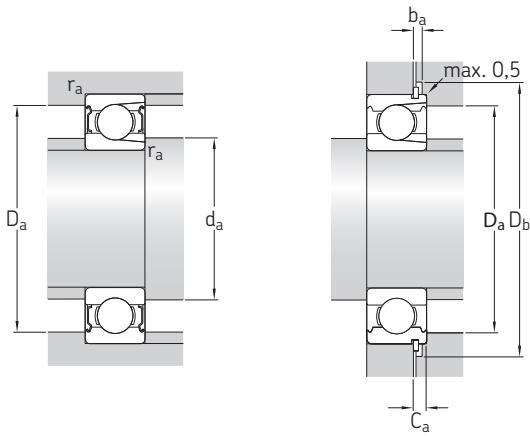

Dimensions								Abutment and fillet dimensions								Minimum load factor	
d	d ₁ ≈	D ₂ ≈	D ₃	D ₄	b	f	C	r _{1,2} min.	r ₀ max.	d _a min.	d _a max.	D _a max.	D _b min.	b _a min.	C _a max.	r _a max.	k _r
mm										mm						-	
85	104	134,3	145,24	159,7	3,1	2,82	4,9	2	0,6	96	-	139	162	3,5	7,72	2	0,04
	104	134,3	-	-	-	-	-	2	-	96	96	139	-	-	-	2	0,04
	104	134,3	-	-	-	-	-	2	-	96	96	139	-	-	-	2	0,04
	112	155,4	-	-	-	-	-	3	-	98	-	167	-	-	-	2,5	0,05
	112	155,4	-	-	-	-	-	3	-	98	112	167	-	-	-	2,5	0,05
	112	155,4	-	-	-	-	-	3	-	98	112	167	-	-	-	2,5	0,05
90	110	142,6	155,22	169,7	3,1	2,82	4,9	2	0,6	100	-	150	172	3,5	7,72	2	0,04
	110	142,6	-	-	-	-	-	2	-	100	110	150	-	-	-	2	0,04
	110	142,6	-	-	-	-	-	2	-	100	110	150	-	-	-	2	0,04
	119	163,9	-	-	-	-	-	3	-	103	-	177	-	-	-	2,5	0,05
	119	163,9	-	-	-	-	-	3	-	103	118	177	-	-	-	2,5	0,05
	119	163,9	-	-	-	-	-	3	-	103	118	177	-	-	-	2,5	0,05
95	116	151,3	163,65	182,9	3,5	3,1	5,69	2,1	0,6	107	-	158	185	4	8,79	2	0,04
	116	151,3	-	-	-	-	-	2,1	-	107	116	158	-	-	-	2	0,04
	116	151,3	-	-	-	-	-	2,1	-	107	116	158	-	-	-	2	0,04
100	123	159,9	-	-	-	-	-	2,1	-	112	-	168	-	-	-	2	0,04
	123	159,9	-	-	-	-	-	2,1	-	112	122	168	-	-	-	2	0,04
	123	159,9	-	-	-	-	-	2,1	-	112	122	168	-	-	-	2	0,04

1.6 Double row deep groove ball bearings

d 10 – 75 mm

1.6

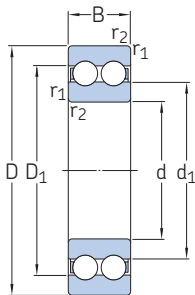

Principal dimensions			Basic load ratings		Fatigue load limit	Speed ratings		Mass	Designation
d	D	B	dynamic	static		Reference speed	Limiting speed		
mm			C	C ₀	P _u	r/min		kg	–
10	30	14	9,23	5,2	0,224	40 000	22 000	0,049	4200 ATN9
12	32	14	10,6	6,2	0,26	36 000	20 000	0,052	4201 ATN9
	37	17	13	7,8	0,325	34 000	18 000	0,092	4301 ATN9
15	35	14	11,9	7,5	0,32	32 000	17 000	0,059	4202 ATN9
	42	17	14,8	9,5	0,405	28 000	15 000	0,12	4302 ATN9
17	40	16	14,8	9,5	0,405	28 000	15 000	0,09	4203 ATN9
	47	19	19,5	13,2	0,56	24 000	13 000	0,16	4303 ATN9
20	47	18	17,8	12,5	0,53	24 000	13 000	0,14	4204 ATN9
	52	21	23,4	16	0,68	22 000	12 000	0,21	4304 ATN9
25	52	18	19	14,6	0,62	20 000	11 000	0,17	4205 ATN9
	62	24	31,9	22,4	0,95	18 000	10 000	0,34	4305 ATN9
30	62	20	26	20,8	0,88	17 000	9 500	0,29	4206 ATN9
	72	27	41	30	1,27	16 000	8 500	0,5	4306 ATN9
35	72	23	35,1	28,5	1,2	15 000	8 000	0,4	4207 ATN9
	80	31	50,7	38	1,63	14 000	7 500	0,68	4307 ATN9
40	80	23	37,1	32,5	1,37	13 000	7 000	0,5	4208 ATN9
	90	33	55,9	45	1,9	12 000	6 700	0,95	4308 ATN9
45	85	23	39	36	1,53	12 000	6 700	0,54	4209 ATN9
	100	36	68,9	56	2,4	11 000	6 000	1,25	4309 ATN9
50	90	23	41	40	1,7	11 000	6 000	0,58	4210 ATN9
	110	40	81,9	69,5	2,9	10 000	5 300	1,7	4310 ATN9
55	100	25	44,9	44	1,9	10 000	5 600	0,8	4211 ATN9
	120	43	97,5	83	3,45	9 000	5 000	2,15	4311 ATN9
60	110	28	57,2	55	2,36	9 500	5 300	1,1	4212 ATN9
	130	46	112	98	4,15	8 500	4 500	2,65	4312 ATN9
65	120	31	67,6	67	2,8	8 500	4 800	1,45	4213 ATN9
	140	48	121	106	4,5	8 000	4 300	3,25	4313 ATN9
70	125	31	70,2	73,5	3,1	8 000	4 300	1,5	4214 ATN9
75	130	31	72,8	80	3,35	7 500	4 000	1,6	4215 ATN9
	160	55	156	143	5,5	6 700	3 600	4,8	4315 ATN9

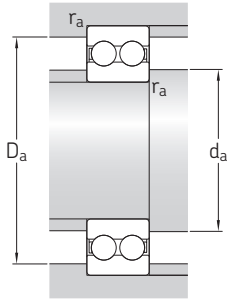

Dimensions				Abutment and fillet dimensions			Calculation factors	
d	d ₁ ≈	D ₁ ≈	r _{1,2} min.	d _a min.	D _a max.	r _a max.	k _r	f ₀
mm				mm			–	
10	16,7	23,3	0,6	14,2	25,8	0,6	0,05	12
12	18,3 20,5	25,7 28,5	0,6 1	16,2 17,6	27,8 31,4	0,6 1	0,05 0,06	12 12
15	21,5 24,5	29 32,5	0,6 1	19,2 20,6	30,8 36,4	0,6 1	0,05 0,06	13 13
17	24,3 28,7	32,7 38,3	0,6 1	21,2 22,6	35,8 41,4	0,6 1	0,05 0,06	13 13
20	29,7 31,8	38,3 42,2	1 1,1	25,6 27	41,4 45	1 1	0,05 0,06	14 13
25	34,2 37,3	42,8 49,7	1 1,1	30,6 32	46,4 55	1 1	0,05 0,06	14 13
30	40,9 43,9	51,1 58,1	1 1,1	35,6 37	56 65	1 1	0,05 0,06	14 13
35	47,5 49,5	59,5 65,4	1,1 1,5	42 44	65 71	1 1,5	0,05 0,06	14 13
40	54 56,9	66 73,1	1,1 1,5	47 49	73 81	1 1,5	0,05 0,06	15 14
45	59,5 63,5	71,5 81,5	1,1 1,5	52 54	78 91	1 1,5	0,05 0,06	15 14
50	65,5 70	77,5 90	1,1 2	57 61	83 99	1 2	0,05 0,06	15 14
55	71,2 76,5	83,8 98,5	1,5 2	64 66	91 109	1,5 2	0,05 0,06	16 14
60	75,6 83,1	90,4 107	1,5 2,1	69 72	101 118	1,5 2	0,05 0,06	15 14
65	82,9 89,6	99,1 115	1,5 2,1	74 77	111 128	1,5 2	0,05 0,06	15 14
70	89,4	106	1,5	79	116	1,5	0,05	15
75	96,9 103	114 132	1,5 2,1	84 87	121 148	1,5 2	0,05 0,06	16 14

1.6 Double row deep groove ball bearings

d 80 – 90 mm

1.6

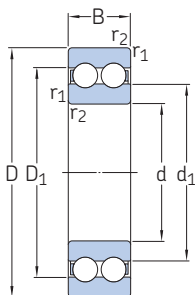

Principal dimensions			Basic load ratings		Fatigue load limit	Speed ratings		Mass	Designation
d	D	B	dynamic C	static C ₀		Reference speed	Limiting speed		
mm			kN		kN	r/min		kg	–
80	140	33	80,6	90	3,6	7 000	3 800	2	4216 ATN9
85	150	36	93,6	102	4	7 000	3 600	2,55	4217 ATN9
90	160	40	112	122	4,65	6 300	3 400	3,2	4218 ATN9

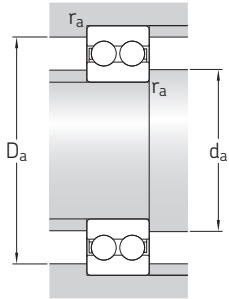

Dimensions				Abutment and fillet dimensions			Calculation factors	
d	$d_1 \approx$	$D_1 \approx$	$r_{1,2}$ min.	d_a min.	D_a max.	r_a max.	k_r	f_0
mm				mm			-	
80	102	120	2	91	129	2	0,05	16
85	105	125	2	96	139	2	0,05	15
90	114	136	2	101	149	2	0,05	15